

Strut Nut Socket

CR-MO

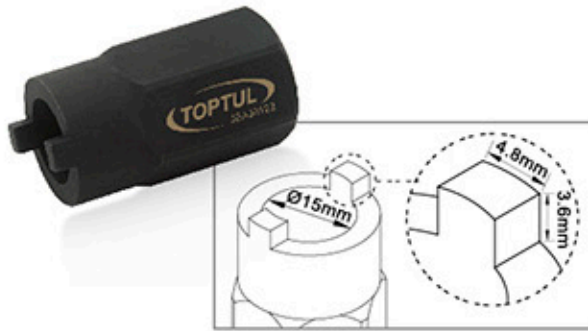

- Suitable for the removal and installation of top shock retaining nut
- Location pegs fit into slots cut in the retaining ring and allow hex key access through the center for release/adjustment of the shock
- Use with 22mm (7/8") spanner
- Material: Heat treated and tempered Chrome Molybdenum Steel (CR-MO)
- Application: Suitable for most VW, AUDI vehicles

ITEM NO.	L (mm)	W	H
JEAJ0122	44 (1-3/4")	6	144

Multi-Purpose Inner Tie Rod Tool

CR-MO



- The master tie rod tools are specially designed to easily replace inner tie rod ends without disassembling the rack and pinion
- Operated with 1/2 inch square drive hand tools

ITEM NO.	CAPACITY (mm)	W	H
JEAH0142	33 - 42	10	40

Disc Brake Piston Spreader

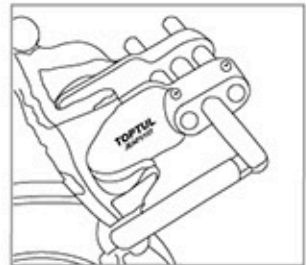
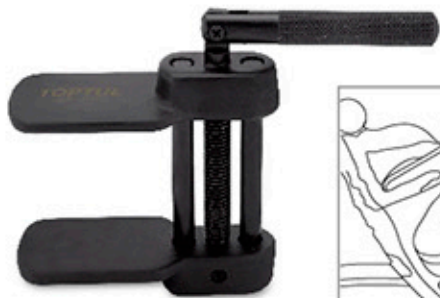

- Chemically blackened steel spreader plates
- Fits in brake caliper to push back pistons for new brake pads installation
- For installing pads on most domestic and import cars and light trucks
- Maximum pusher width: 70mm (2-3/4")

ITEM NO.	CAPACITY (mm)	W	H
JEAF0107	0 - 70 (0 - 2-3/4")	1	18

Brake Spring Pliers

Satin Chrome Finished

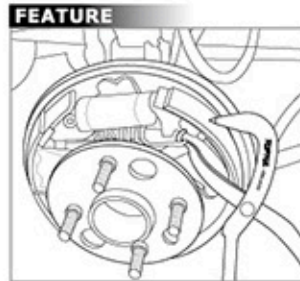
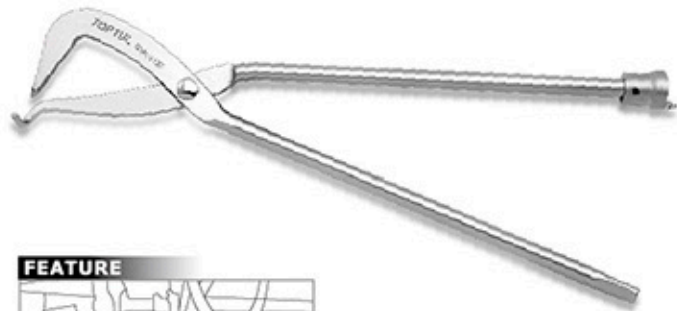

- Use to remove and install shoe return springs on most drum brakes
- Special socket end design removes spring from anchor stud, notched end installs spring on anchor

ITEM NO.	LENGTH (mm)	W	H
JDAL0133	325 (12-3/4")	6	48

Wheel Balancing Weight Pliers With Invisible Spring

CR-V



- Special tool for balancing automotive tires and wheels; installs, removes, trims, levers, hammers and tightens all type of click-on wheel weights

ITEM NO.	LENGTH (mm)	W	H
JEAA1010	250 (10")	10	40

Tire Lever

CR-V



- For tire mounting and removing

ITEM NO.	LENGTH (mm)	W	H
JCAB2821D	530 (21")	10	20

C.V. Joint Banding Tool (with cutter)

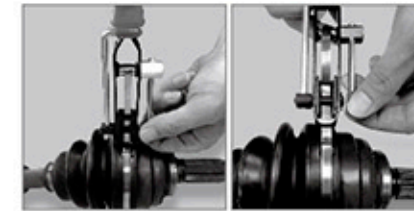

- Use to install and tighten the band-it and strap style clamp on CV joint boots, power steering rack and pinion steering gear boots
- Bands are installed into the tool and tightened by turning the tool handle
- Use a 1/2" socket/wrench or by hand to wind the band until sufficient tension is applied
- When boot clamp has been tightened to specs, the built in cutter cuts the band by flipping tool lever (at the front of the tool) forward
- Tool is easily removed by sliding sideways after the band is tightened

ITEM NO.	LENGTH (mm)	W	H
JEAE0423	230 (9")	20	60

CV Boot Clamp Pliers - Ear Type



- Designed to crimp the ear-type CV boot clamps used on front-wheel drive vehicles
- Pliers serve as a hose clamp installer for easy installation of Perma-Quick type hose clamps on fuel filters, water pumps, other cooling system hoses and CV joint boot clamps
- Comfort grip handle

ITEM NO.	LENGTH (mm)	W	H
JEAE0310	265 (10-1/2")	12	48

CV Boot Clamp Pliers - Earless Type

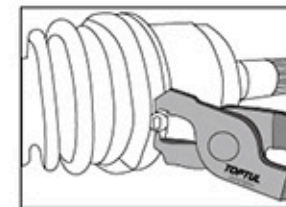

- Designed to install & remove earless type clamps
- Quickly remove CV joint boot clamps
- Grips clamp in various position to tighten clamp around
- Works on earless-type clamps including GM inboard CV joints

ITEM NO.	LENGTH (mm)	W	H
JEAE0209	240 (9-1/2")	12	72

Front Wheel Drive Axle Puller (Steel Cable Type)



ITEM NO. JEAG0198

- Feature: Use the extendable and adjustable steel cable to clip the axle/drive shaft tightly. Pull out the axle/drive shaft with slide hammer easily
- Material: Body (Iron), Slide Hammer (Cast Iron), Cable (Steel)
- Maximum Steel Cable Diameter: 100mm I.D.
- Overall Length: 980mm

CV Boot Clamp Pliers - Ear Type (Extension)



- Designed to crimp the ear-type CV boot clamps
- 1/2" 4 point recess in the handle for additional use with 1/2" drive ratchet, torque wrench and etc.
- Comfort grip handle

ITEM NO.	LENGTH (mm)	W	H
JEAE0509	240 (9-1/2")	12	36

Clic-R Collar Pliers

CR-MO

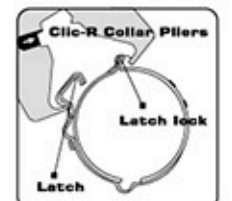

- For releasing and refitting the new style Clic and Clic-R reusable hose clamp clips
- Spring actuated joint, soft grip handles

ITEM NO.	LENGTH (mm)	W	H
JEAE0107	180 (7")	12	72

# Auto Tools - Undercar Series

## Ball Joint Separator

CR-MO



- Drop forged steel body and bolt for long and rough usage
- Suitable for most small cars and light vans

ITEM NO.	JAW SIZE (mm)	MAX. JAW OPENING (mm)	L (mm)	Weight (kg)	Length (mm)
JEAB0116	19	50	160	1	20

## Universal Ball Joint Separator

CR-MO

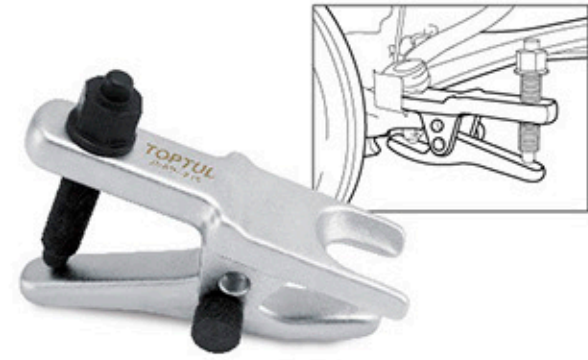

- Drop forged steel body and bolt for long and rough usage
- Special design two stage operation provides 30mm & 55mm maximum opening
- Suitable for most small cars and light trucks ball joints in steering and suspension

ITEM NO.	JAW SIZE (mm)	MAX. JAW OPENING (mm)	L (mm)	Weight (kg)	Length (mm)
JEAB0216	22	55	160	1	20

## Fork Type Ball Joint Separator

CR-MO



- Tempered drop forged steel with one piece construction for long and rough usage
- Robust fork with long length stem replaces worn out ball joints easily with a hammer striking

ITEM NO.	FORK OPENING (mm)	L (mm)	Weight (kg)	Length (mm)
JEAB0330	24	300	10	20
JEAB0440	18	400	10	20

## Universal Ball Joint Separator

CR-V

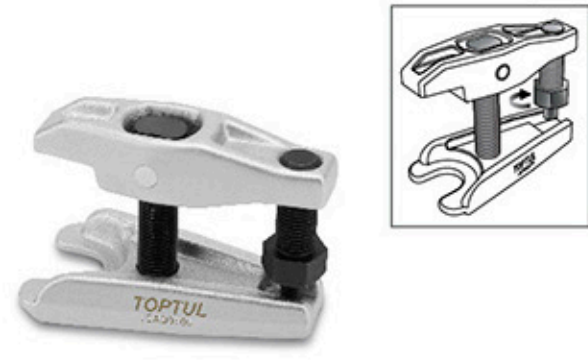

- For splitting track-rod ends, anti-roll bar mountings, ball joints and etc.

ITEM NO.	JAW SIZE (mm)	MAX. JAW OPENING (mm)	L (mm)	Weight (kg)	Length (mm)
JEAB0505	22	50	100	1	30

## Ball Joint Separator

- Drop forged steel body and bolt for long and rough usage
- Suitable for splitting track rod ends, anti-roll bar mountings, steering ball joints and etc.

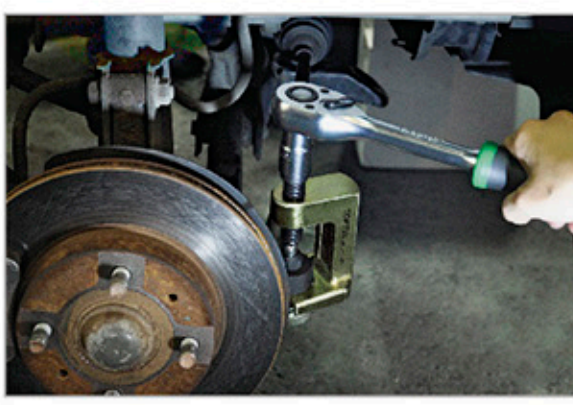
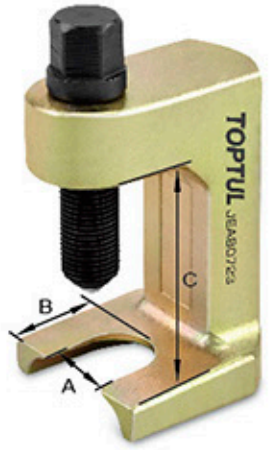

ITEM NO.	Jaw Size A (mm)	B (mm)	C (mm)	Thread (mm)	Weight (mm)	Applicable	Weight (kg)	Length (mm)
JEAB0723	23	25	55	M16 x 1.5 x 50	17	Audi, BMW, Citroen, Ford, Mercedes, Opel, Peugeot, Renault, Rover, Saab, Volvo, VW etc.	1	24
JEAB0728	28	25	55	M16 x 1.5 x 50	17	Audi A4-A6-A8, VW, Passat ab '97 etc.	1	24

## Ball Joint Separator

- Drop forged steel body and bolt for long and rough usage
- Suitable for splitting track rod ends, anti-roll bar mountings, steering ball joints and etc.

CR-MO

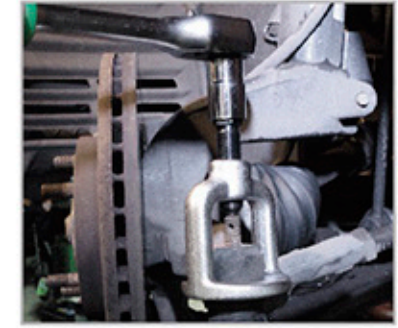
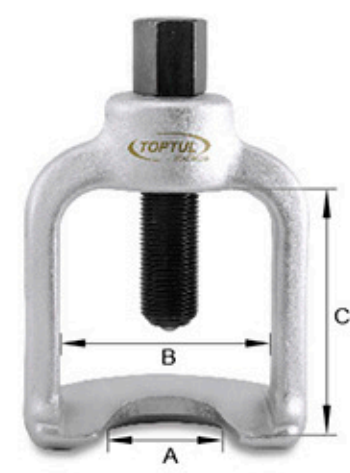

ITEM NO.	Jaw Size A (mm)	B (mm)	C (mm)	Thread (mm)	Weight (mm)	Length (mm)
JEAB0618	18	36	38	M14 x 1.5 x 50	17	1 48
JEAB0623	23	45	47	M16 x 1.5 x 70	17	1 12
JEAB0629	29	62	65	M18 x 1.5 x 90	19	1 12
JEAB0640	40	63	76	7/8"-14 UNF x 135	24	1 12
JEAB0646	46	76	100	7/8"-14 UNF x 135	24	1 12

## Pitman Arm Puller

- Drop forged steel body and bolt for long and rough usage
- Design to remove tie rod ends and pitman arm assemblies from most car and light trucks

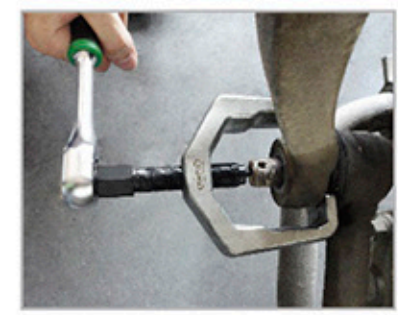
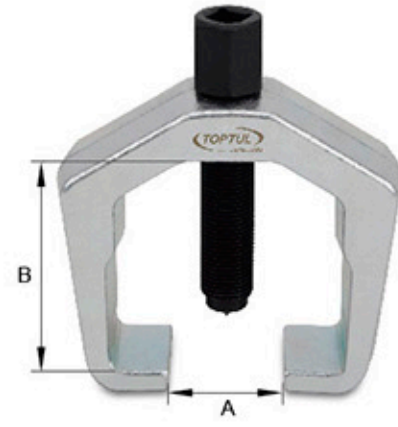

ITEM NO.	Jaw Size A (mm)	B (mm)	Thread (mm)	Weight (mm)	Length (mm)
JEAB0833	33	64	5/8"-18 UNF x 86	19	6 24

## Hub Slide Hammer Puller

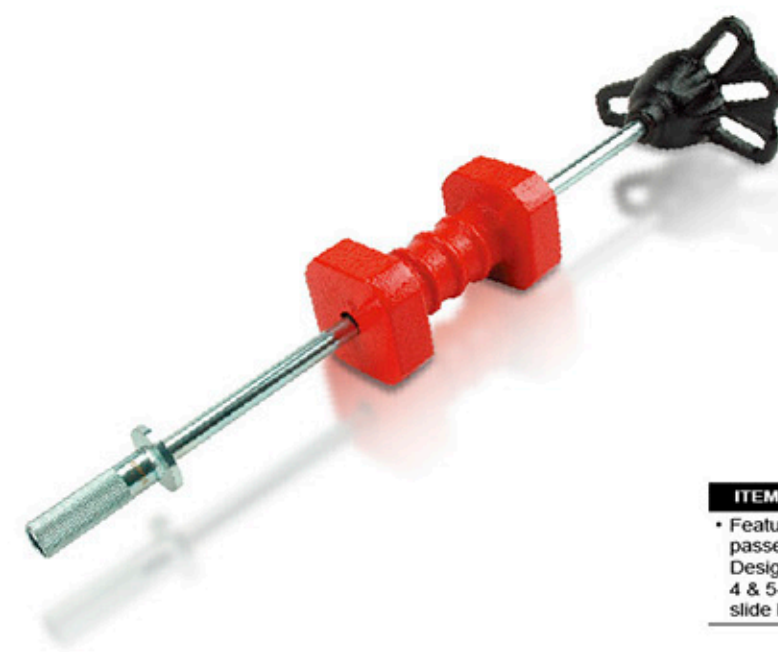

- Features: Pulls and removes flange-type rear axles on most late model passenger cars and light trucks. Designed to work on axles with bolts and studs up to 9/16" diameter. Fits 4 & 5-bolt pattern hub, stud circle diameter range from 4" - 6". Heavy duty slide hammer action with 10 lbs (4.5kgs) hammer for tough pulling jobs

ITEM NO.	JEAI0167
----------	----------

Slide Hammer Puller Set



ITEM NO. JGAI1303 2 (SET)

**Features:** Most commonly used tool set to pull and removes flange-type real axles, oil seals, bearings and press-fits parts. Designed to work on multi-purpose works and 8 functional assembly; external 3-jaw puller, internal 3-jaw puller, external 2-jaw puller, internal 2-jaw puller, grip wrench adapter, puller hook, rear axle puller, dent puller to suits different pulling & removing jobs.

BLOW CASE: W600 x D210 x H100 (mm)

KIT CONTENT

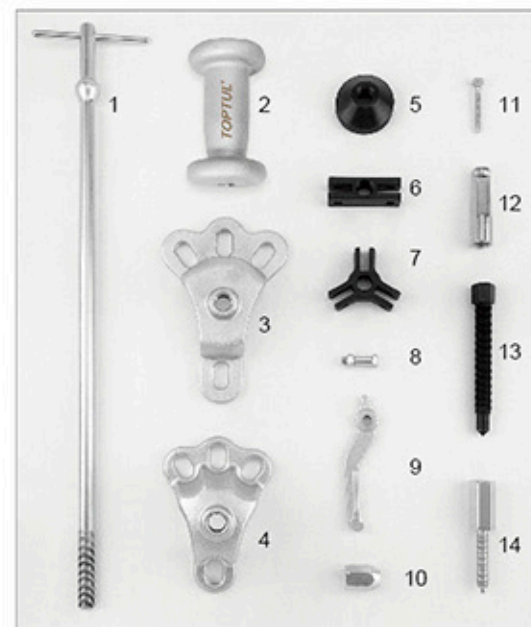

NO.	Description	Q'ty
1	T Bar	1
2	Hammer	1
3	Axle Puller	1
4	Deep Axle Puller	1
5	Cone	1
6	2 Jaw Head	1
7	3 Jaw Head	1
8	Nut & Bolt	3
9	Jaw	3
10	Attachment	1
11	Screw	1
12	Hook	1
13	Centre Screw	1
14	Grip Wrench Adapter	1

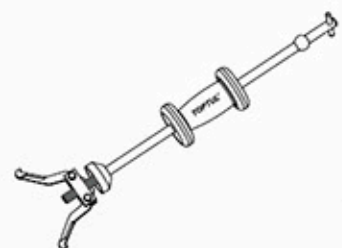

Internal 2-Jaw Puller

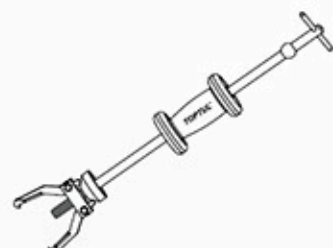

External 2-Jaw Puller



Internal 3-Jaw Puller

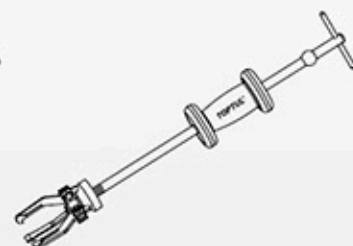

External 3-Jaw Puller

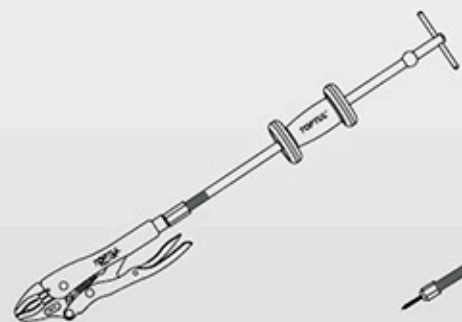

Grip Wrench Adapter



Dent Puller

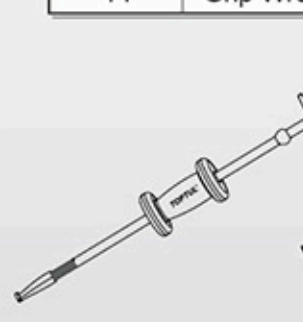

Puller Hook

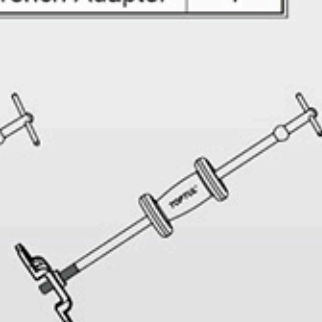

Rear Axle Puller

36PCS Self-Adjusting Clutch Alignment Tool Kit



ITEM NO. JGAI3601 2 (SET)

**Features:** Suitable for most self adjusting clutches SAC (3 and 4 points) equipped on vehicles of VW, Audi, BMW, Fiat Group, Mercedes, Opel, Renault, Volvo etc. Tool kits allow operations on clutch with this device can prevent any damage to system and to keep adapter ring in right position. Necessary tools for easy pre-tensioning self adjusting clutches before removal or installation. Prevents clutch plate distortion and avoid unexpected of clutch from disengaging or dragging. Equipped a refitting tool, can allow the clutch adjuster to be wound back, and ten alignment adapters. Alignment of clutch disk to drive bearing & disk pushing plate. Kit includes a clamping tool for SAC clutches with 3(4) hole pitch, a compression strut, 2 handle for clamping tool, a face spanner, a clutch resetting tool, 10 alignment adapter, 4 threaded bolts - M6, M7 and M8, 4 knurled nuts, 4 screw - M8.

BLOW CASE: W435 x D400 x H82 (mm)



Clamping Tool



Pretension clutch



Ten Alignment Adapter



Resetting Tool



Face spanner (Audi, Seat, Skoda and VW)



**3PCS**  
1/2" DR. Hub Nut Deep Impact Socket Set

CR-MO



- Heavy duty, professional quality 12-point deep impact sockets manufactured from hardened and tempered Chrome Molybdenum Steel
- Suitable for hub nut applications where high torque is required
- Set contains three sockets for a sure grip on the most common sized hub nuts
- Black phosphate finish for added corrosion resistance
- Applications: Audi, VW, Alfa, BMW, Citroen, Fiat, Ford, Mercedes, Opel, Peugeot, Renault and etc.

ITEM NO.	CONTENTS	10 (SET)
GDAI0303	KABJ1630-1636 1/2" Dr. 12PT Flank Deep Impact Sockets (78mmL) 30, 32, 36 mm	

BLOW CASE: W170 x D105 x H70 (mm)

**1/2" DR. Spline Bit Impact Sockets**

Black Phosphate Finished (SNCM+V)



DRIVE	ITEM NO.	SIZE	L(mm)	1	2
1/2" 12.7mm SQ.	KADB1614S	M14	44	25	250
	KADB1616S	M16	44	25	250
	KADB1618S	M18	44	25	250
	KADB1614L	M14	77	15	120
	KADB1616L	M16	77	15	120
	KADB1618L	M18	77	15	120

**6PCS**  
1/2" DR. Spline Impact Socket Bit Set

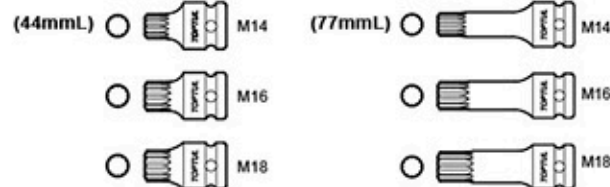

- Expert quality, tempered and hardened Nickel Chrome Molybdenum Steel (SNCM+V) socket bits
- Spline bit M14/M16/M18, each size in two lengths 44 & 77 mmL
- Suitable for removal and adjustment of hubs, steering and suspension on VAG vehicles and etc.
- Use with 1/2" square drive impact tools
- Black phosphate finish for extended corrosion resistance

ITEM NO.	CONTENTS	20 (SET)
GDAI0601	KADB1614S-KADB1618S 1/2" Dr. Spline Bit Impact Sockets (44mmL) M14, M16, M18 KADB1614L-KADB1618L 1/2" Dr. Spline Bit Impact Sockets (77mmL) M14, M16, M18	

BLOW CASE: W130 x D107 x H53 (mm)

**8PCS**  
Lug Nut Remover / Wheel Lock Removal Tool Kit

CR-MO



- Made of Chrome Molybdenum Steel
- Standard 1/2" square drive socket
- Impact-grade hardened and tempered socket
- 8-piece set fits small, medium, large lug nuts and locks
- Deep reverse-tapered internal threads to grip the locking wheel nut or stripped lock on most vehicles
- Removes factory and most aftermarket wheel lug nut lock without factory original key
- Thin wall design socket fit wheel lock diameter to prevent scratching wheels
- Suitable for use with 1/2" drive impact tools
- Black phosphate finish for extra corrosion resistance

ITEM NO.	CONTENTS	12 (SET)
JGAI0802	JEAK1617-1628 1/2" Dr. Locking Wheel Nut Removal Sockets 17, 18.5, 20, 21.5, 23, 24.5, 26, 27.5 mm	

BLOW CASE: W250 x D155 x H55 (mm)



• Deep reverse-tapered internal threads inside the socket wall to grip the locking wheel nut or stripped lock

**12PCS**  
Universal Caliper Disc Brake Wind Back Tool Kit



- Magnetic socket adapter
- Including 10 adapters for brake assemblage
- For rotating pistons back into caliper to provide clearance for new pads
- Prevents damage to the piston and boot
- Suitable for V.W, Audi, Ford, Nissan, Alfa Romeo, Rover, Saab, Subaru, Toyota, Jaguar and most of the general motors

ITEM NO.	CONTENTS	10 (SET)
JGAI1201	1 Right hand threaded rewind tool 1 Reaction plate 10 Brake piston adapters	

BLOW CASE: W325 x D255 x H50 (mm)



- This tool is designed to wind back brake caliper pistons when servicing brake calipers or replacing brake pads
- Expert Quality, left hand and right hand threaded rewind tools allow the easy return of the brake piston into the caliper to provide clearance for new brake pads
- Application for most cars, such as Audi, Ford, Nissan, Alfa Romeo, Saab, Subaru, BMW, Toyota, Jaguar, VW, GM and etc.

ITEM NO.	CONTENTS	8 (SET)
JGAI1801	2 Left and right hand threaded rewind tools 1 Reaction plate 15 Brake piston adapters	

MacPherson Spring Dumper Extractor (Replaceable)

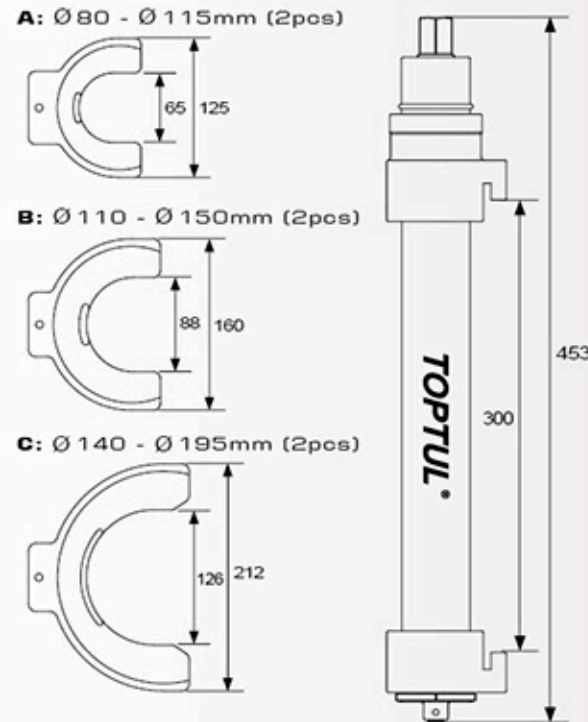

**ITEM NO.** JGAI0801 **1 (SET)**

- Spring compressors are multi-application tools specifically developed for MacPherson suspensions, using a range of 3 sets of interchangeable mono block forks / jaws
- The assembly / disassembly of the springs at all types of MacPherson strut
- For MacPherson shock absorber springs and equivalent shock absorber
- Application: BMW, Toyota, Ford, Mitsubishi, VW, Audi, Saab, Nissan, Honda, Accord, Subaru, Volvo, Opel and Porsche
- Material: Chrome Molybdenum Steel
- Spring Specification / Use Range:
  - A: Ø 80 - Ø 115 mm
  - B: Ø 110 - Ø 150 mm
  - C: Ø 140 - Ø 195 mm
- Max. Load: 3,500 kgf
- Hand-operated tools

BLOW CASE: W530 x D460 x H110 (mm)



**No impact / power drive.**

2PCS Coil Spring Compressor Set

CR-MO

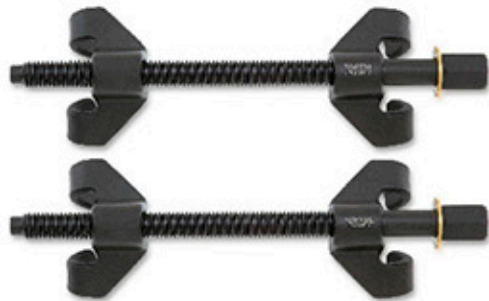

- Drop forged chrome molybdenum steel jaws and lead screws (270mm)
- For use with 21mm wrench or 1/2" square drive tools
- Jaw design is suitable for use in confined areas under wheel arch
- The tool is designed to wrap coil claws for safety

ITEM NO.	MAX. JAW OPENING	Hand	Set
JEAC0127	270 mm	1	6

2PCS Coil Spring Compressor Set

CR-MO



- Drop forged chrome molybdenum steel jaws and lead screws (370mm)
- For use with 21mm wrench or 1/2" square drive tools
- Jaw design is suitable for use in confined areas under wheel arch
- The tool is designed to wrap coil claws for safety

ITEM NO.	MAX. JAW OPENING	Hand	Set
JEAC0137	370 mm	1	6

8PCS Pressure Screw Bearing Separator Puller Set



• Pull out the bearing with the H-type beam and bolts

ITEM NO.	CONTENTS	Hand	Set
JGAD0801	1 Bearing Separator Set (Capacity 75 - 105mm)	2	(SET)
	2 Main Rod		
	2 Extension Rod		
	1 Beam		
	1 Central Bolt		
	1 Central Nut		

METAL CASE: W447 x D188 x H53 (mm)

12PCS Bearing Separator Kit

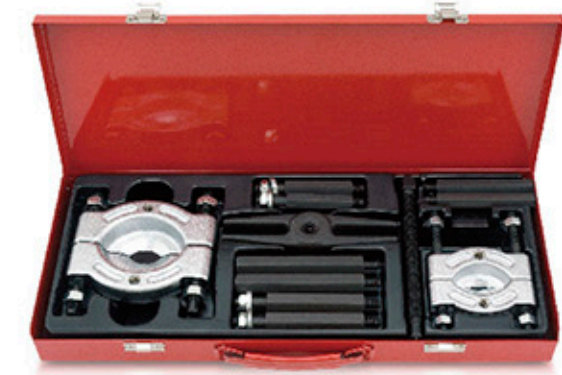

• Pull out the bearing with the H-type beam and bolts

ITEM NO.	CONTENTS	Hand	Set
JGAD1201	1 Bearing Separator Set (Capacity 30 - 50mm)	3	(SET)
	1 Bearing Separator Set (Capacity 50 - 75mm)		
	1 Main Rod		
	1 Extension Rod		
	1 Beam		
	1 Central Bolt		

METAL CASE: W447 x D188 x H53 (mm)

Bearing Separator Set

CR-MO



ITEM NO.	SIZE(mm)	EXTENSION ROD	Hand	Set
JEAD0305	30 - 50	3/8" - 16T	1	20
JEAD0508	50 - 75	3/8" - 16T	1	12
JEAD0811	75 - 105	M12 x 1.75P	1	10
JEAD1115	105 - 150	5/8" - 11T	1	5

24PCS FWD Front Wheel Bearing Removal & Installation Tool Kit



**ITEM NO.** JGAI2401 **2 (SET)**

- Comprehensive kit for the removal and installation of front hub bearings
- Remove and replace front hub bearings without the need to dismantle the steering knuckle and strut assembly
- Works on both domestic and imported FWD cars and light trucks
- Black phosphate finish for corrosion resistance
- 14 sizes bearing cap diameter: 50, 55, 59, 63.3, 66.5, 70.3, 71.5, 73.1, 73.4, 74.8, 77.5, 81.5, 83.4, 88.4 mm
- 4 sizes barrel diameter: 76, 86, 91, 102 mm
- 2 sizes barrel cap diameter: 86, 102 mm
- Use with 27mm or 32mm wrench or socket

BLOW CASE: W430 x D390 x H105 (mm)



# 3-Function Tire Pressure Gauge



Variable Trigger & Control Position  
Simple & Easy Operation Model  
Ideal for Automotive & Truck Tires

## PROFESSIONAL TIRE INFLATOR WITH GAUGE



**Pressure Display Range**

- 0 - 160 psi
- 0 - 11 bar

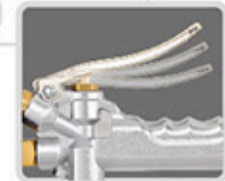

SPECIFICATIONS

### Variable Trigger & Control Position

Gauge Pressure / Measuring (Release)  
Release Air / Deflation (Press Halfway Down)  
Fill Air / Inflation (Press Down)

## 3-Function Tire Pressure Gauge

- Multi-Function Tire Pressure Gauge:
  1. Check Pressure
  2. Inflate
  3. Deflate
- Pressure Range: 0 - 160 psi, 0 - 11 bar
- Flexible 20" high pressure rubber hose with clip-on air tire chuck
- Variable trigger, two control position inflate/deflate level
- Simple and easy operation model
- Ideal for automotive tires
- Air Inlet: 1/4" PT

ITEM NO. JEAL160A 12 (SET)

## 3-Function Tire Pressure Gauge



Convenient Clip-On Tire Chuck

ITEM NO. JEAL220A 12 (SET)

- Multi-Function Tire Pressure Gauge:
  1. Check Pressure
  2. Inflate
  3. Deflate
- Large and easy-reading 3-1/2" diameter gauge with protective rubber sleeve
- Pressure Range: 0 - 15 kg/cm<sup>2</sup>, 0 - 220 psi, 0 - 15 bar, 0 - 1500 kpa
- Aluminum die-casting body with H-D brass valves
- Flexible 20" high pressure rubber hose
- Clip-on air tire chuck design enables hands-free chuck use
- Variable trigger, two control position inflate/deflate level
- Simple and easy operation model
- Ideal for automotive tires especially truck tires
- Built in hang-up hook allows for easy storage
- Air Inlet: 1/4" PT

## 3-Function Tire Pressure Gauge W/ Dual Tire Chuck



10" Chrome Plated Steel Dual Chuck (Offset Dual Head Air Tire Chuck)

ITEM NO. JEAL220B 12 (SET)

- Multi-Function Tire Pressure Gauge:
  1. Check Pressure
  2. Inflate
  3. Deflate
- Large and easy-reading 3-1/2" diameter gauge with protective rubber sleeve
- Pressure Range: 0 - 15 kg/cm<sup>2</sup>, 0 - 220 psi, 0 - 15 bar, 0 - 1500 kpa
- Aluminum die-casting body with H-D brass valves
- Flexible 40" high pressure rubber hose with 10" chrome plated steel dual chuck
- Offset dual head air tire chuck allows easy access to all valves
- Variable trigger, two control position inflate/deflate level
- Simple and easy operation model
- Ideal for automotive tires especially truck tires
- Built in hang-up hook allows for easy storage
- Air Inlet: 1/4" PT

## Dual Tire Chuck

- Chrome-plated steel dual air tire chuck
- Offset dual head chuck allows easy access to all tire valve stems
- Ideal for automobile tires especially truck tires
- Comfort, Anti-slip plastic grip handle
- Air inlet: 1/4" PT
- Head I.D.: 8mm



ITEM NO.	LENGTH (mm)	Weight	Quantity
JEAM0821	205 (8")	5	100
JEAM1437	370 (14")	5	100

## Brake Fluid Tester

- Designed for checking quality of brake fluid (DOT 4)
- Five LED to indicate the percentage of water in the brake fluid
- Quick & simple tool for testing brake fluid in most type of vehicles, trucks, motorcycles



CE RoHS

Water Content	LED Indication	Status
0%	Green	Batt
<1%	Green/Yellow	Ok
<2%	Yellow	Ok
<3%	Green/Yellow/Red	Warning
>4%	Red	Danger

- LED indication
- Green: Battery OK, no water contained in the brake fluid
  - Green/Yellow: Less than 1% of water content in brake fluid
  - Green/Yellow/Red: Approx. 2% of water content in brake fluid
  - Green/Yellow/Red: Approx. 3% of water content in brake fluid
  - The brake fluid should be changed
  - Green/Yellow/Red/Red: At least 4% of water content in brake fluid
  - The brake fluid must be changed urgently

ITEM NO. JJDB0101

ITEM NO.	LENGTH (mm)	Weight	Quantity
JJDB0101	150	10	100

**Unique Compression Tester Kit (Petrol Engine)**



**ITEM NO.** JGAI0402 6 (SET)

- Use to check cylinder compression to assist in the diagnosis of faulty valves, piston rings, cylinder heads, gaskets and etc.
- Large, shock protected, easy-reading 2-1/2" diameter gauge with dual calibration 0 - 300 psi, 0 - 21 kg/cm<sup>2</sup>
- Gauge head with pressure release valve for repeated test of cylinder without removing gauge
- 13" durable rubber extension hose with built in M14 adapter and one separate M18 adapter
- 8" heavy-duty aluminum extension tube with universal rubber cone adapter fits all plug holes

**BLOW CASE:** W270 x D145 x H60 (mm)

**Compression Tester Set (Diesel Engine)**



**ITEM NO.** JGAI1302 6 (SET)

- Comprehensive test kit for checking compression on both direct and indirect injection diesel engine vehicles
- Large, shock protected, easy-reading 2-1/2" diameter gauge with dual calibration 0 - 1000 psi, 0 - 70 bar
- Gauge head with built-in pressure release valve for repeated test of cylinder without removing gauge
- 15" flexible hose allows easy access to restricted plug and injector ports
- Quick-connect coupler for easy and secure connection
- Includes replacement seal & washer set
- Applications: BMW, VW, Volvo, Renault, Mercedes-Benz, Fiat, Citroen, Opel, Peugeot, Toyota, Nissan, Isuzu, Mazda, Mitsubishi, Ford and etc.

**BLOW CASE:** W378 x D310 x H48 (mm)

**Multi-Port Fuel Injection Pressure Tester Kit**



The uniquely designed pressure relief valve



The quick coupling system



**ITEM NO.** JGAI0703 6 (SET)

- Excellent fuel injection pressure test kit assists in identifying and diagnosing low fuel pressure, a faulty fuel pressure regulator, leaking injectors, fuel leaks and clogged fuel filters
- Large, shock protected, easy-reading 3-1/2" diameter fuel pressure gauge with dual scale reading of 0 - 150 psi and 0 - 1000 kPa
- All adapters, gauge and hose assemblies feature a quick coupling system for speedy and efficient testing connection
- For Multi-Port Fuel Injection (MFI) system
- Applications: American vehicles Ford, Chrysler, GM and etc.

**BLOW CASE:** W592 x D261 x H62 (mm)

**Gasoline Engine Fuel Injection Pressure Tester Kit**



Hook Up The Gauge Easily



Attach The Gauge To The Hood Easily



The Unique Designed Relief Valve



The Quick Coupling System

**ITEM NO.** JGAI8101 2 (SET)

- Excellent fuel injection pressure test kit assists in identifying and diagnosing low fuel pressure, a faulty fuel pressure regulator, leaking injectors, fuel leaks and clogged fuel filters
- Large, shock protected, easy-reading 3-1/2" diameter fuel pressure gauge with dual scale reading of 0 - 120 psi and 0 - 8 bar
- Comprehensive kit of adapters and fittings for most fuel injection systems of American, Japanese, European vehicles including Multi-Port Fuel Injection (MFI) system, GM TBI system and Bosch CIS system
- Kit contains gauge, hose, adapters, tubing, manifolds, plugs plus repair kits of spare washers, seals, o-rings, clamps, fuel hose, bushes and other accessories.
- Applications: BMW, VW, Audi, Volvo, Saab, Ford, Chrysler, Fiat, Honda, Hyundai, Isuzu, Mazda, Porsche, GM, Mercedes-Benz, Peugeot, Suzuki, Toyota, Mitsubishi, Jeep and etc.

**BLOW CASE:** W380 x D430 x H160 (mm)

**Cooling System Vacuum Purge & Refill Kit** -NEW



**ITEM NO.** JGAI0302 5 (SET)

- Check the leakage of original radiator cap and cooling system
- Easy reading 2" diameter pressure gauge with dual scale reading of -76 - 0 cmHg and -1 - 0 bar
- Vacuum leakage test for easy identification and prevent coolant spillage and wastage
- Eliminates the introduction of bubbles and airlock into cooling system and deduct the time for refilling coolant
- Kit includes a pressure gauge, connector, universal rubber cone-shape adapter, cooling hose and air bleeding hose
- Applications: almost all type of vehicles

**BLOW CASE:** W390 x D330 x H100 (mm)

**18PCS**  
Universal Radiator Pressure Tester Kit



ITEM NO. JGAI1802 4 (SET)

- Check the leakage of original radiator cap and cooling system
- Hand pressure pump and leakage testing adapters made of hard and durable Nylon 66 material (PA66)
- Easy reading 2-1/2" diameter pressure gauge with protective rubber sleeve
- Pressure Range: 0 - 35 psi, 0 - 2.5 bar with pressure release valve and quick coupler
- Color coded radiator leakage testing adapters for easy identification
- Kit includes a pressure testing pump with gauge, a thermometer needle, 13 radiator kits, 2 connectors and an adapter handle
- Applications: VW, Audi, Volvo, Saab, Mercedes-Benz, BMW, Renault, Porsche, Jaguar, Mitsubishi, Mazda, Toyota, Honda, Suzuki, Isuzu, Ford, GM, Chrysler, Fiat, Alfa Romeo, Lexus, Opel, Peugeot, Jeep, Land Rover, Citroen and etc.

BLOW CASE: W470 x D405 x H110 (mm)

**28PCS**  
Universal Radiator Pressure Tester & Vacuum Type Cooling System Kit



ITEM NO. JGAI2801 2 (SET)

- Check the leakage of original radiator cap and cool system
- Hand pressure pump and leakage testing adapters made of hard and durable Nylon 66 material (PA66)
- Easy reading 2-1/2" pressure gauge and 2" vacuum pressure gauge
- Pressure range: 0 - 35 psi / 0 - 2.5 bar
- Vacuum pressure range: -76 - 0 cmHg / -1 - 0 bar
- Specially included vacuum purge & refill kit for easy identification and prevent coolant spillage and wastage
- Color coded radiator leakage testing adapters for easy identification
- Kit includes a pressure testing pump with gauge, vacuum pump, a thermometer needle, 20 radiator kits, 2 connectors, adapter handle, universal cone-shape adapter, coolant hose and exhaust hose
- Applications: VW, Audi, Volvo, Saab, Mercedes-Benz, BMW, Renault, Porsche, Jaguar, Mitsubishi, Mazda, Toyota, Honda, Suzuki, Isuzu, Ford, GM, Chrysler, Fiat, Alfa Romeo, Suzuki, Lexus, Opel, Peugeot, Jeep, Land Rover, Citroen and etc.

BLOW CASE: W600 x D510 x H110 (mm)

**Curved Hose Clamp Pliers**

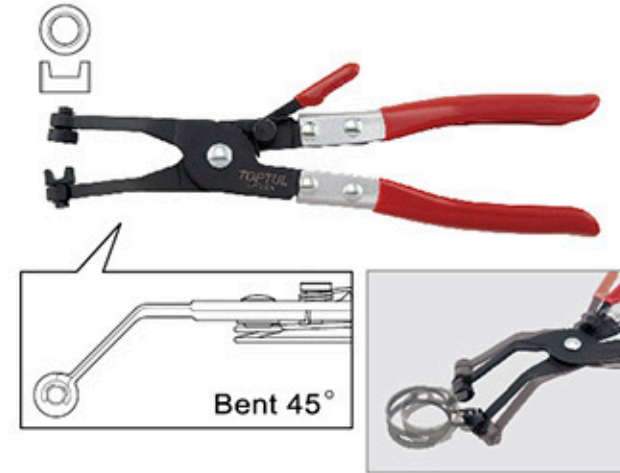

- Finger tip "position lock" design for easy replacement of lower radiator hose
- 45° bending design to fit clamps in deep position

ITEM NO.	LENGTH (mm)	Weight	Box Qty
JDAM039C	235 (9-1/4")	6	48

**Straight Tip Lock Ring Pliers**



- Used to spread snap rings found on brakes, pedal shaft, transmissions, clutch shafts, machine tools, and some piston rings
- Jaws are scored on outside for secure gripping
- Drop forged alloy steel, spring loaded joint, comfort grip handle

ITEM NO.	LENGTH (mm)	SPREAD (mm)	Weight	Box Qty
JDAP0109	215 (8-1/2")	25 (1")	6	72

**Angle Tip Lock Ring Pliers**



ITEM NO.	LENGTH (mm)	SPREAD (mm)	Weight	Box Qty
JDAP0209	215 (8-1/2")	25 (1")	6	72

**Hose Clamp Pliers**



- Finger tip "position lock" design for easy replacement of lower radiator hose

ITEM NO.	LENGTH (mm)	Weight	Box Qty
JDAM028E	215 (8-1/2")	6	60

**Flexible Hose Clamp Pliers**

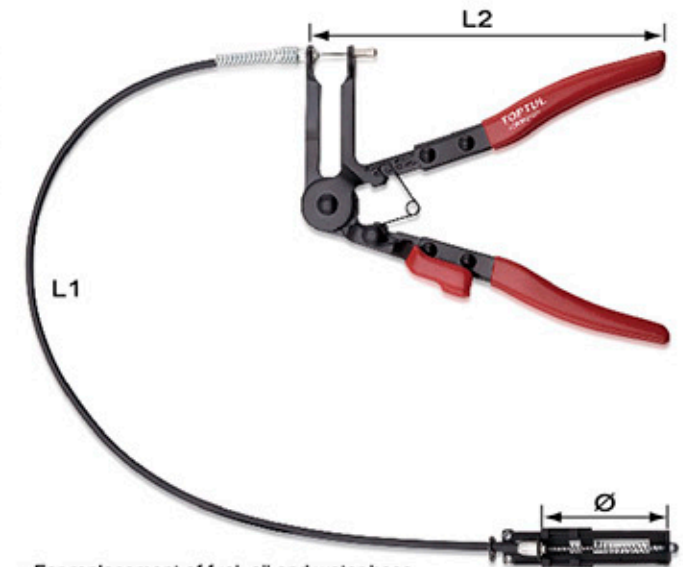

- For replacement of fuel, oil and water hose
- Hose clamp with flexible 630mm wire
- Suitable to work in hidden areas and long distance

ITEM NO.	L1 (mm)	L2 (mm)	Max. Ø (mm)	Weight	Box Qty
JDAM0163	630	225	53	12	36

**3PCS**  
Flexible Line Clamp Set



ITEM NO.	CONTENTS	Weight	Box Qty
JGAR0301	1 JDAY0119 Small Line Clamp - Ø6 - 19mm (1/4" - 3/4") 1 JDAY0132 Medium Line Clamp - Ø13 - 32mm (1/2" - 1-1/4") 1 JDAY0157 Large Line Clamp - Ø19 - 57mm (3/4" - 2-1/4")	10 (SET)	



**Valve Spring Compressor Kit (One Man Operation Type)**

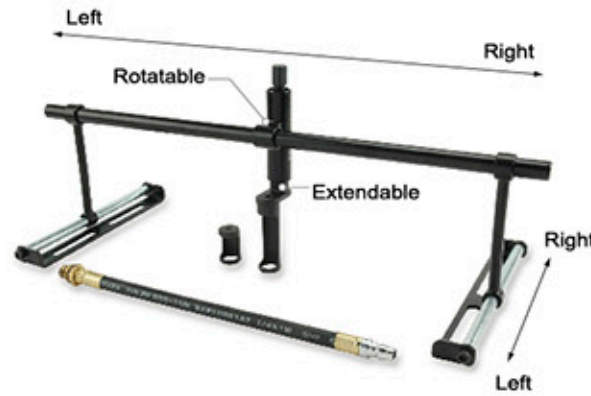

ITEM NO. JDAN0222

5 (SET)

- Easy for single use, operated by a thread bar to fix on right place
- Recessed pocket on valve pusher allows replacement retrieval of valve collets
- Complete service tool kit for installation and removal of the valve spring without removing the cylinder head from the engine
- Valve pusher size: Ø 22mm
- Application: 12V, 16V, 20V, 24V engine

BLOW CASE: W570 x D240 x H60 (mm)

**Valve Spring Compressor**



- Reversible jaw adapter for multi-valve engines
- Dual size in adapter 25mm & 30mm adapter

ITEM NO.	CAPACITY (mm)	6	3
JDAN0143	35 - 200		

**7PCS**

**Valve Spring Compressor Kit**



**5 INTERCHANGEABLE DRIVING ADAPTERS**



- This tool kit is designed to compress and release valve spring after removing the collets
- Arched-type steel tube lever ensures a consistent coaxial contact with the valve
- Includes 5 interchangeable driving adapters to fit valve springs: 16mm, 19mm, 23mm, 25mm, 30mm
- Driving adapters are made of heat treated Chrome Molybdenum Steel
- 2 Length pressure screws: 50mm & 90mm
- Ideal to use on cars, motorcycles and small bore engines applications
- Hand-operated tool kit

ITEM NO.	CAPACITY (mm)	THROAT DEPTH (mm)	12
JGAI0702	30 - 130	100	

BLOW CASE: W340 x D195 x H50 (mm)

**Valve Stem Seal Pliers**

- High quality metal Seal Removal Tool removes valve stem seals from overhead camshaft engines
- Valve pliers reach down around the valve stem into the confined area of the seal for easy removal
- Gripping serration in the pliers tip easily grabs both original equipment and aftermarket seals regardless of their configuration
- Jaws are serrated for a secure grip on the seal

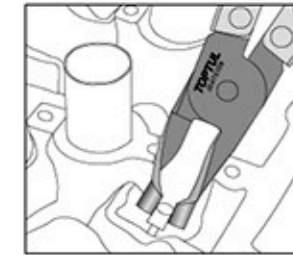

ITEM NO.	LENGTH (mm)	6	48
JDAT0109	245 (9-1/2")		

**Angular Torque Gauge**

- Full circle 360° angle scale. Clearly marked in 2 degree increments & in intervals of 10 & 30 degrees
- Adjustable arm keeps angle gauge scale stationary, wedge it against object while turning drive tool
- Accommodates 1/2" male and female square drive

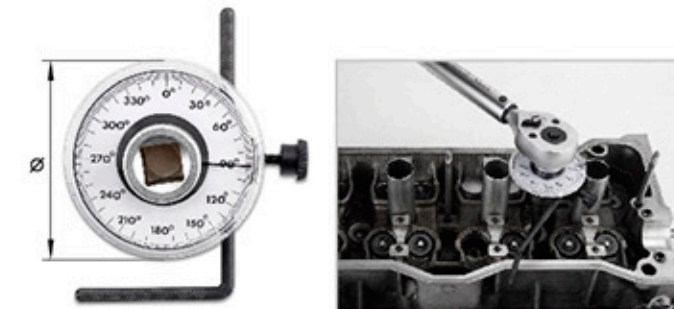

ITEM NO.	DRIVE (inch)	Ø (mm)	12	48
JDAW1602	1/2" (F) x 1/2" (M)	68		

**Angular Torque Gauge**

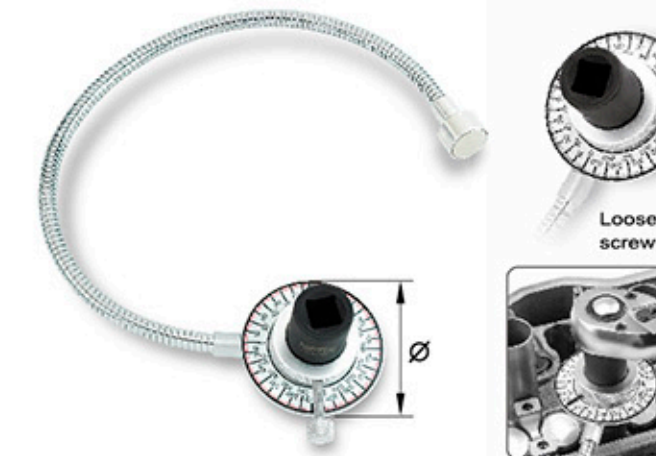

**3-Leg Engine Cylinder Hone (Range 2" - 7")**

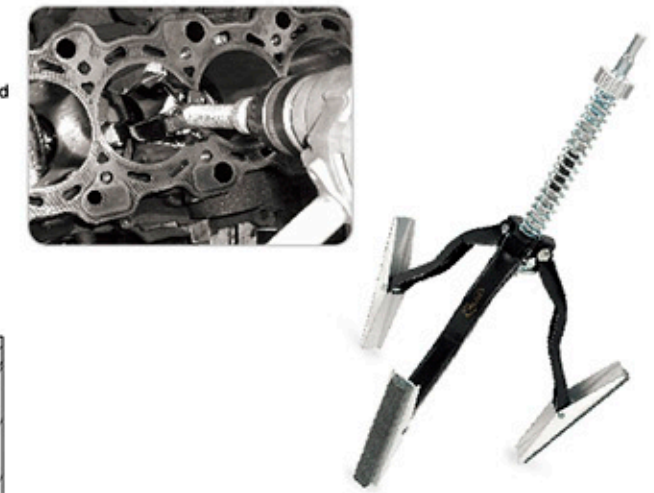

- Suitable to use with standard 1/4" or any electric drill. Use appropriate fluid for cutting lubricant. Interchangeable honing
- Supplied complete with 4" (100mm) long 180 grit stones
- Capacity: 2" to 7" (51 - 177mm) in diameter
- Overall Length: 12" (300mm)
- Application: Automotive brake and clutch cylinders, engine cylinders of motorcycles, lawn mowers, outboard motors, hydraulic cylinders, machine and industrial engines and etc.

ITEM NO.	CAPACITY	L (mm)	10	40
JDBE0718	Ø 2" - Ø 7"	300		

**3PCS**

**Engine Cylinder Hone Replacement Stone Set**



- For general purpose honing and glaze breaking
- Silicon carbide grinding stones bonded to aluminum alloy steel holders
- #180 medium grit stones
- Stone Dimension: 4" (L) x 13/32" (W)
- Set includes 3pcs stones and cotter pins

ITEM NO.	JLAF1804	25 (SET)

ITEM NO.	DRIVE	Ø (mm)	L (mm)	15	30
JDAW1601	1/2" (F) x 1/2" (M)	63	480		

**2PCS**

**Valve Grinder Set**

- For hand grinding flat head, unslotted valves
- Synthetic rubber vacuum cups are resistant to oil, grease and gasoline
- 2 pieces in blister card packing



Place grinding compound on valve face and put in seat. Put suction cup on valve head and turn handle between hands to grind.

ITEM NO.	CONTENTS	Hand	Case
JGAR0201	1 JDBQ2026 Valve Grinder Tool Cup diameters: 5/8", 13/16" (for smaller valves)	12	108
	1 JDBQ3644 Valve Grinder Tool Cup diameters: 1-1/8", 1-3/8" (for larger valves)		

**7PCS**

**Diesel Injector Seat Cutter Set**

- Specially designed for cleaning and re-cutting injector seats for all common rail diesel engines
- To avoid "blow-by" occurring cause of possible build-up of carbon deposits and corrosion
- Application for all modern common rail diesel engines



ITEM NO.	CONTENTS	Hand	Case
JGAI0704	1 T-Handle Socket Wrench 19 mm 1 Pilot Post 1 Flat Reamer 15 x 19, 17 x 17, 17 x 19 mm 1 Angled Reamer 17 x 21 mm 1 Hex Key Wrench 2.5 mm	10 (SET)	

BLOW CASE: W217x D165 x H50 (mm)

**Heavy Duty Seal Puller**

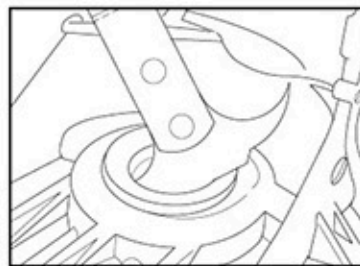

- Removes Oil & Grease Seals
- Two Tips Fit Most Application

ITEM NO.	LENGTH (mm)	Hand	Case
JDAK0132	318 (12-1/2")	12	48

**Oil Service Wrench**



- Chrome Vanadium Steel Material
- Bent, size 8mm and 10mm outside male square
- Suitable for the removal of oil drain and filler plug on gearbox, sump and differential
- Applications: Citroen, Peugeot, Renault and etc.

ITEM NO.	SIZE (mm)	L (mm)	Hand	Case
JEL-0810	8 x 10	230	10	40

**14PCS**

**3/8" DR. Master Oil Drain Plug Key Set**



- Popular keys for draining differentials, sumps, axles and gearboxes on most modern vehicles
- Drain plug keys made of hardened and tempered chrome vanadium steel
- Suitable for use with 3/8" square drive tools
- Applications: BMW, Citroen, Fiat, Ford, Honda, Lancia, Mazda, Mercedes, Nissan, Peugeot, Renault, Toyota, Volvo, Volkswagen and etc.

ITEM NO.	CONTENTS	Hand	Case
JGAI1402	1 JDBF1208-1217 3/8" Dr. Oil Drain Plug Hexagon Key 8, 9, 10, 12, 14, 17 mm 1 JDBH1207-JDBH1213 3/8" Dr. Oil Drain Plug Square Key 7, 8, 11, 13 mm 2 JDBJ1210 & 1212 3/8" Dr. Oil Drain Plug Square Key 5/16" & 3/8" 1 JDBK1210 3/8" Dr. Oil Drain Plug Female Square Key 10 mm 1 JDBL1210 3/8" Dr. Oil Drain Plug Triangle Key 10 mm	25 (SET)	

BLOW CASE: W220 x D90 x H47 (mm)

**14PCS**

**Master Oil Drain Plug Key Set**



- Popular keys for draining differentials, sumps, axles, gearboxes on most modern vehicles
- Drain plug keys made of hardened and tempered chrome vanadium steel
- Suitable for use with 17mm wrenches or sockets
- Black phosphate finished
- Applications: BMW, Citroen, Fiat, Ford, Honda, Lancia, Mazda, Mercedes, Nissan, Peugeot, Renault, Volvo, Volkswagen and etc.

ITEM NO.	CONTENTS	Hand	Case
JGAI1403	1 JDCF1708-1717 Oil Drain Plug Hexagon Key 8, 9, 10, 12, 14, 17 mm 1 JDCG1712 Oil Drain Plug Hexagon Key 3/8" 1 JDCJ1708-1713 Oil Drain Plug Square Key 8, 9, 10, 11, 12, 13 mm 1 JDCM1716 Oil Drain Plug Triple Square Tamperproof Key M16H	15 (SET)	

BLOW CASE: W252x D120 x H40 (mm)

**Oil Screw Socket (M16H)**



- Made of Chrome Vanadium Alloy Steel
- For removing and installing of the gearbox drain plug
- Operated by 17mm wrench or socket
- Applicable: AUDI, VW oil screws and etc.

ITEM NO.	SIZE (mm)	SIZE	L (mm)	Hand	Case
JDBB1617	17	M16H	38	10	180

**1/2" DR. Oil Drain Plug Socket**



- Made of expert quality, hardened and tempered Chrome Molybdenum Steel Material
- A special 12 point (triple square) tamperproof socket used to remove the transmission drain plug
- Tamperproof design for removing and installing the oil release bolts/screws on the transmission and gearbox
- Application: Audi A4-A6, VW Passat, Porsche Boxster and etc.

ITEM NO.	DRIVE	SIZE	L (mm)	Hand	Case
JDBC1616	1/2"	M16H	60	10	60

**Oil Filter Master Plier**

- High quality Chrome Vanadium Alloy Steel
- Professional heat treated and machined
- Adjustable locking pliers design filter wrench
- Nickel plated finish
- Jaws Opening Range: 2-1/8" to 4-5/8" (53mm - 118mm)

CR-V

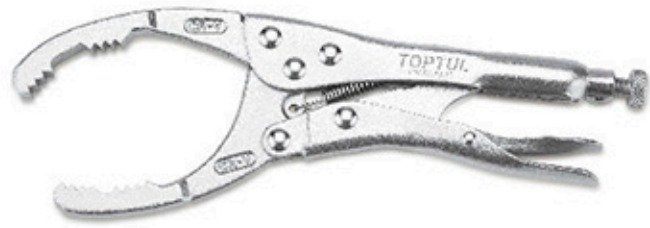

ITEM NO.	SIZE(inch)	W	L
DMAC1A10	10	12	48

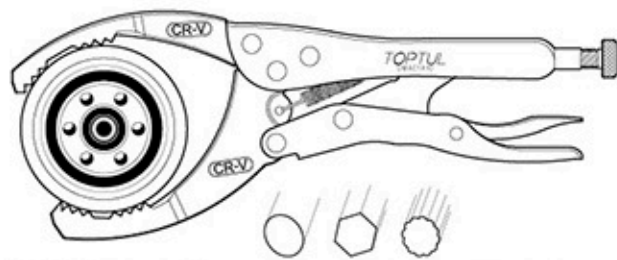

**Multi-Purpose Plier**

Suitable for installing, removing and tightening objects of any shape.

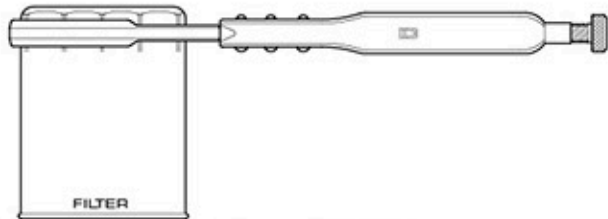

This plier can be adjusted and fastened for applications at any angle.

**Oil Filter Pliers**

- Drop forged pliers body for strength
- 3 position slip-joint design
- Serrated jaws and long handles for extra grip



ITEM NO.	SIZE(inch)	CAPACITY Ø (mm)	W	L
JDAA1010	10	60 - 90 (2-3/8" - 3-1/2")	10	40
JDAA1212	12	57 - 110 (2-1/4" - 4-5/16")	10	40

**Professional Swivel Handle Oil Filter Wrench**

- Heavy duty oil filter wrench
- Swivel handle allows user to reach filters in hard to reach places
- Wide band securely grips filters without crushing
- Easy grip comfortable handle

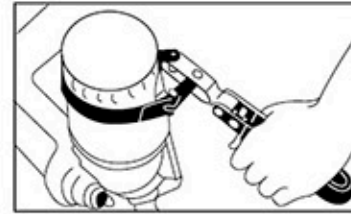

ITEM NO.	CAPACITY Ø (mm)	W	L
JDAU6073	60 - 73 (2-3/8" - 2-7/8")	6	36
JDAU7385	73 - 85 (2-7/8" - 3-3/8")	6	36
JDAU8595	85 - 95 (3-3/8" - 3-3/4")	6	36
JDAU95B0	95 - 110 (3-3/4" - 4-3/8")	6	36

**Nylon Strap Oil Filter Wrench**

- Removes any oil filters up to 12" (300mm) diameter
- Strong, non-slip nylon webbing strap
- Use with 3/8" or 1/2" square drive tools



ITEM NO.	MAX. CAPACITY Ø (mm)	W	L
JDAV1630	300 (12")	10	40

**Nylon Strap Oil Filter Wrench**

- Removes any oil filters up to 6" (152mm) diameter
- Strong, non-slip nylon webbing strap
- Use with 1/2" square drive tools



ITEM NO.	MAX. CAPACITY Ø (mm)	W	L
JDAV1615	152 (6")	12	48

**Heavy Duty Chain Wrench**

- Heavy duty heat treated chain
- Chrome molybdenum steel handle
- Serrated jaws allows sure ratcheting action in either direction
- Long steel handle for added leverage
- Cushioned soft grip allows a better grip and less hand fatigue
- Ideal for filter removal, turning larger pipes and holding pulleys



• JJAH1203



• JJAH2003

ITEM NO.	GRIPPING CAPACITY Ø (mm)	CHAIN LENGTH (inch)	HANDLE LENGTH (inch)	W	L
JJAH1203	13 - 152 (1/2" - 6")	20	12	20	20
JJAH2003	76 - 172 (3" - 6-3/4")	24-1/2	20	10	10

**Strap Wrench**



ITEM NO.	CAPACITY Ø (mm)	L(inch)	W	L	W
JJAH0902	30 - 160	9	10	60	60

**Chain Wrench**



ITEM NO.	CAPACITY Ø (mm)	L(inch)	W	L	W
JJAH0901	30 - 160	9	25	50	50

**Chain Wrench**



- Tempered and hardened high-grade tool steel chain and body
- Double-hinge construction for high clamping power
- Ratchet-style action design works in both directions
- Flexible handle enables to work in narrow spaces
- Ideal for automotive oil filter replacement
- Chain length: 350mm (14")

ITEM NO.	CAPACITY Ø (mm)	L(mm)	W	L
JDBA60A5	60 - 105	225	5	20

**Metal Strap Oil Filter Wrench**



- Band type filter wrench, adjustable by turning knob
- Steel strap with light, heavy duty aluminum alloy body and die-cast control knob
- Removes filters with minimal risk of damage
- Ideal for automotive oil filter replacement
- Suitable for one-hand operation in areas of restricted access

ITEM NO.	CAPACITY Ø (mm)	MAX. LENGTH(mm)	W	L
JDAZ65B0	65 - 110	290	10	50

361 **Auto Tools - Engine Series**

**3-Legged Oil Filter Wrench**

- Filter Capacity: 65 - 120mm (2-1/2" to 4-3/4")
- Removes all sizes of oil filters from 65 to 120mm in diameter
- Use with 1/2" or 3/8" square drive tool or 21mm wrench/socket
- Suitable for most cars and light trucks



ITEM NO.	CAPACITY Ø (mm)	🔧	📦
JDAI65A2	65 - 120 (2-1/2" - 4-3/4")	12	48

**Two Way Oil Filter Wrench**

- Remove oil filters from 66 - 94 mm diameter
- Use with 3/8" square drive tool or 17 mm wrench

CR-MO



ITEM NO.	CAPACITY Ø (mm)	🔧	📦
JDAA0808	66 - 94	6	36

**Two Way Oil Filter Wrench**

- Special serrated design for easy to grip filter without slipping
- Installed springs, ideal for assisting user to hold filter quickly
- Use with 1/2" square drive tool

NEW  
CR-MO



ITEM NO.	CAPACITY Ø (mm)	● (mm)	🔧	📦
JDCA0108	60 - 80	21	6	36
JDCA0112	80 - 115	22	1	8
JDCA0114	115 - 140	24	1	4

**Cup Type Oil Filter Wrench**

• JDAHA815



• JDAHA818



• JDAH7615



• 3/8" SQ. Drive



TYPE	ITEM NO.	SIZE (mm)	FLUTES	🔧	📦
A	JDAH6414	64 (2-1/2")	14	12	72
	JDAH6514	65 (2-9/16")	14	12	72
	JDAH6814	68 (2-11/16")	14	12	72
	JDAH7314	73 (2-7/8")	14	12	72
	JDAH7415	74 (2-29/32")	15	12	72
	JDAH7608	76 (3")	8	12	72
	JDAH7614	76 (3")	14	12	72
	JDAH8015	80 (3-9/64")	15	12	72
	JDAH8616	86 (3-3/8")	16	12	72
	JDAH9015	90 (3-17/32")	15	12	72
	JDAH9210	92 (3-40/64")	10	12	72
	JDAH9315	93 (3-21/32")	15	12	72
B	JDAHA015	100 (4")	15	12	72
	JDAHA615	106 (4-11/64")	15	12	72
	JDAHA815	108 (4-8/32")	15	12	72
	JDAH6606	66 (2-19/32")	6	12	72
	JDAH7612	76 (3")	12	12	72
	JDAH7630	76 (3")	30	12	72
	JDAH8618	86 (3-3/8")	18	12	72
	JDAH9336	93 (3-21/32")	36	12	72
	JDAH9345	93 (3-21/32")	45	12	72
	JDAH9618	96 (3-3/4")	18	12	72
	JDAH818	108 (4-8/32")	18	12	72
	C	JDAH7615	74 - 76 (2-29/32" - 3")	15	12
JDAH7715		75 - 77 (2-15/16" - 3-1/32")	15	12	72

**16PCS**

Automotive Cup Type Oil Filter Wrench Set



• Suitable for European Vehicles

ITEM NO.	CONTENTS	📦 (SET)
JGAI1601	1 66mm (2-19/32") - 6 Flutes-1 Step 1 74 - 76mm (2-29/32" - 3") - 15 Flutes-1 Step 1 76mm (3") - 8 Flutes-1 Step 1 76mm (3") - 12 Flutes-1 Step 1 76mm (3") - 14 Flutes-1 Step 1 86mm (3-3/8") - 16 Flutes-1 Step 1 86mm (3-3/8") - 18 Flutes-1 Step 1 92mm (3-40/64") - 10 Flutes-1 Step 1 93mm (3-21/32") - 15 Flutes-1 Step 1 93mm (3-21/32") - 45 Flutes-1 Step 1 96mm (3-3/4") - 18 Flutes-1 Step 1 106mm (4-11/64") - 15 Flutes-1 Step 1 108mm (4-8/32") - 15 Flutes-1 Step 1 108mm (4-8/32") - 18 Flutes-1 Step 1 3 Legged Oil Filter Tool 65 - 120mm (2-1/2" - 4-3/4") 1 Adapter - 1/2"(F) x 3/8"(M) Drive	5

BLOW CASE: W440 x D320 x H90 (mm)

**14PCS**

Automotive Cup Type Oil Filter Wrench Set



• TOPTUL cup-type oil filter wrenches are made of gauge construction and are able to withstand up to 85 ft-lbs of torque applied. The cup-design grip functions as a socket minimizing the possibility of crushing filters and fits both 3/8" and 1/2" (adapter) square drive tool. The cups are coated with electro-black oxide finish for long life protection against rust

• Suitable for Japanese Vehicles

ITEM NO.	CONTENTS	📦 (SET)
JGAI1401	1 64mm (2-1/2") - 14 Flutes-1 Step 1 65mm (2-9/16") - 14 Flutes-1 Step 1 68mm (2-11/16") - 14 Flutes-1 Step 1 73mm (2-7/8") - 14 Flutes-1 Step 1 74mm (2-29/32") - 15 Flutes-1 Step 1 74 - 76mm (2-29/32" - 3") - 15 Flutes-2 Step 1 76mm (3") - 30 Flutes-1 Step 1 75 - 77mm (2-15/16" - 3-1/32") - 15 Flutes-2 Step 1 80mm (3-9/64") - 15 Flutes-1 Step 1 90mm (3-17/32") - 15 Flutes-1 Step 1 93mm (3-21/32") - 15 Flutes-1 Step 1 93mm (3-21/32") - 36 Flutes-1 Step 1 100mm (4") - 15 Flutes-1 Step 1 Adapter - 1/2"(F) x 3/8"(M) Drive	6

**8PCS BMW Engine Timing Tool Set**

**-NEW**

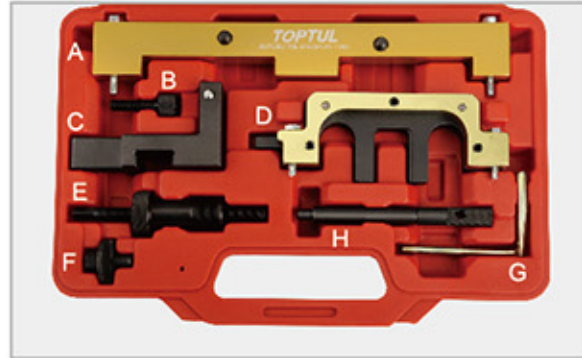

ITEM NO. **JGAI0803** 10 (SET)

- A specific tool set for adjustment and arresting of twin camshaft on petrol engine
- Suitable for checking and adjustment of camshaft timing
- Removal, installation and alignment of VANOUS unit
- Application:  
BMW 118i E81/82/87/88 (04-12) / 120i E81/82/87/88 (04-12) / 316ti Compact E46 (01-07) / 318i E90/91/92/32 (05-12) / 318ti Compact E46 (01-07) / 320i E90/91/92/93 (05-12) / 520i E60/61 (07-10) / X1 sDrive 18i E84 (10-12) / X1 xDrive 18i E84 (10-12) / X3 2.0 E83 (05-10) / Z4 2.0 E85/86 (04-09)
- Engine Code:  
N42/N46/N46T-B18, B18A, B20, B20A, B20B, B20BD, B20BZ, B202

BLOW CASE: W330 x D235 x H50 (mm)

NO.	Description	Q'ty
A	Vanos Alignment Plate	1
B	Camshaft Setting Plate Securing Screw	1
C	Camshaft Setting Plate (Inlet)	1
D	Camshaft Setting Plate (Exhaust)	1
E	Timing Chain Tensioner Pre-Load Tool	1
F	Camshaft Turning Tool	1
G	Flywheel TDC Locking Pin	1
H	Crankshaft Alignment Pin	1

**18PCS BMW Engine Timing Tool Set**

**-NEW**

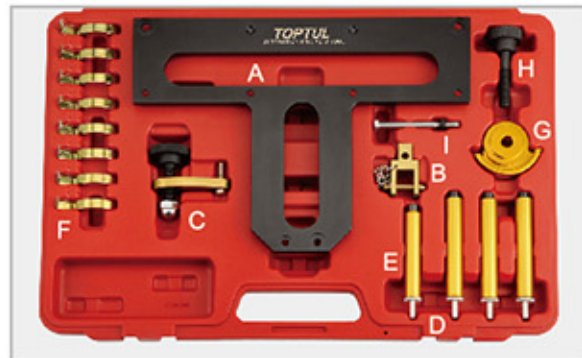

ITEM NO. **JGAI1803** 5 (SET)

- A specific tool set for adjustment and arresting of twin camshaft on petrol engine
- Suitable for installing and removal of inlet camshaft and carrier assembly
- Removal, installation and replacement of VANOS units
- Use with TOPTUL JGAI0803 (8pcs BMW Engine Timing Tool set)
- Application:  
BMW 118i E81/82/87/88 (04-12) / 120i E81/82/87/88 (04-12) / 316ti Compact E46 (01-07) / 318i E90/91/92/32 (05-12) / 318ti Compact E46 (01-07) / 320i E90/91/92/93 (05-12) / 520i E60/61 (07-10) / X1 sDrive 18i E84 (10-12) / X1 xDrive 18i E84 (10-12) / X3 2.0 E83 (05-10) / Z4 2.0 E85/86 (04-09)
- Engine Code:  
N42/N46/N46T-B18, B18A, B20, B20A, B20B, B20BD, B20BZ, B202

BLOW CASE: W450 x D320 x H55 (mm)

NO.	Description	Q'ty
A	Camshaft / Carrier Bracket Mounting Fixture	1
B	Torsion Spring Remover / Installer	1
C	Inlet Camshaft Securing Tool (Rear)	1
D	Mounting Fixture Support - Long	3
E	Mounting Fixture Support - Short	1
F	Intermediate Lever Clamp Set	8
G	Inlet Camshaft Securing Tool (Front)	1
H	Inlet Camshaft Securing Tool (Front) Lock	1
I	Bolt and Nut	1

**Deep Star Sockets (Cylinder Head Bolt Tool)**

- Chrome Vanadium Steel Material
- Specially designed for removing and installing the cylinder head bolts
- Spring-ball locking design can hold the bolt tightly during operation
- Applications: BMW, Mercedes, Opel, Vauxhall and etc.

CR-V

**Ribe Bit Sockets (Cylinder Head Bolt Tool)**

- Chrome Vanadium Steel socket, S2 steel Bit
- Specially designed for use on V.W. and AUDI cylinder head bolts

CR-V+S2



DRIVE	ITEM NO.	SIZE	L(mm)	12.7mm sq.	12.7mm sq.
1/2"	BAEJ1612	E12	140	8	80
	BAEJ1614	E14	140	8	80

DRIVE	ITEM NO.	SIZE	L(mm)	12.7mm sq.	12.7mm sq.
1/2"	BCYA1610S	M10S	100	10	160
	BCYA1610	M10S	140	10	100

• TOPTUL product item no. BCRA1610 can not replace the use of this particular product.

**Crankshaft Locking Tool**

- Special design to lock the crankshafts on VW, AUDI, SEAT, SKODA, 2.0 TDI engine and etc.



• Marking on the right of the locking screw

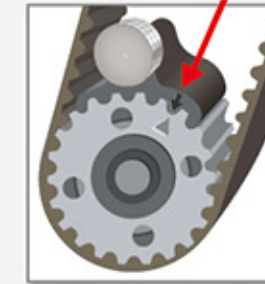

ITEM NO.	LENGTH(mm)	50	100
JDBR2065	65	50	100

**3PCS Crankshaft Timing Belt Pulley Locking Tool Set**

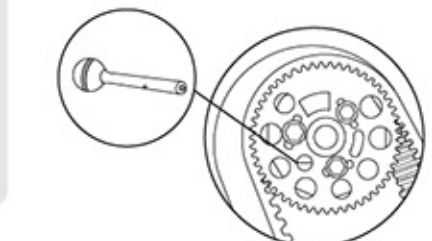

ITEM NO. **JGAR0302** 5 (SET)

- A specific engine timing tool set for Audi, Volkswagen, Seat and Skoda TDI PD and V6 engines
- Contents: Injection Pump Locking Pin, Tensioner Locking Tool, Crankshaft Locking Tool

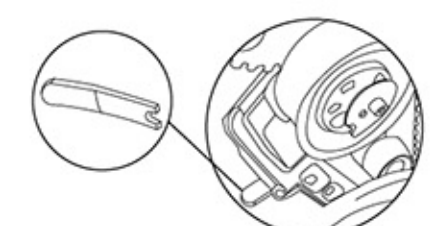

**Pulley Removing Wrench**

- To lock the pulley during removing or assembling any type of pulley retaining bolt
- High flexibility outperforms the traditional standard strap or chain wrench, and will not damage components
- Ideal for water pump, alternator pulleys and various electric motor pulleys of compressors, washing machines, tool machines and etc.
- Also suitable to rotate the cam shaft when timing the engine and to remove oil and gasoline filters



JDAF1437: V-Belt Pulleys



JDAG1437: Poly-V Belt Pulleys



ITEM NO.	CAPACITY Ø (mm)	LENGTH(mm)	🔧	📦
JDAF1437	40 - 140	365 (14 - 3/8")	12	36
JDAG1437	40 - 140	365 (14 - 3/8")	12	36

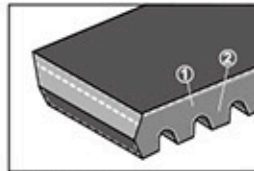

JDAF1437 V-Belt Pulleys

- Cord Tension**  
Low elongation stiff cord is highly resistant to tension and resulting in better power transmission.
- Rib Rubber**  
Fiber-contained rubber is greatly resistant to abrasion and breakage.

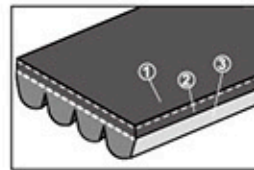

JDAG1437 Poly-V Belt Pulleys

- Cover Fabric**  
Flexible fabric material is resistant to breakage and high temperature and oil-based substances.
- Cord Tension**  
Low elongation stiff cord is highly resistant to tension and resulting in better power transmission.
- Rib Rubber**  
Fiber-contained rubber is greatly resistant to abrasion and breakage.

**Timing Belt Tensioner Adjustment Tool**

- Steel construction
- 2-pin timing belt tensioner tool
- Pin Diameter: 3mm
- Offset design
- Useful for camshaft spur belt tension adjustment
- Application: VW, AUDI and etc.

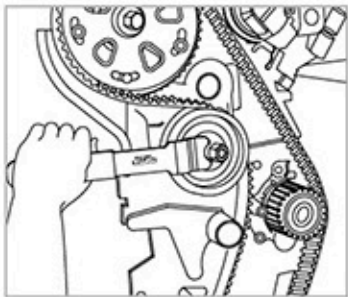

ITEM NO.	LENGTH(mm)	PIN DIAMETER(mm)	🔧	📦
JDBP1703	172	3	20	80

**Injection Pump Wrench**



- Chrome Vanadium Steel Material
- 90° angle for leverage
- Professional quality for maximum durability and corrosion resistance
- Single Box-End Wrench for repair toothed belt or adjust the injection starts, injection pump removal and locking screws
- Applications: 1.6L 4-cyl. Diesel engine AUDI 80, VW Golf, Jetta, Caddy, Passat, Santana, CITROEN

ITEM NO.	SIZE (mm)	L (mm)	🔧	📦
JDBW1316	13	160	10	160

**AUTO TOOLS - ENGINE SERIES**

**Spline Alternator Combination Bit Socket (M10)**



- The two-part alternator socket allows easy removal and replacement of the free-wheel drive pulley at the alternator
- This tool allows the alternator to be locked by the M10 spline bit socket insert and enables the central locking bolt of the pulley to be loosened or tightened by the serrated reaction nut
- Use with 17mm wrench
- 33 teeth hexagonal reaction nut, O.D. 19.5mm
- Applications: BMW, VW, Audi, Ford, Skoda, Mercedes, Porsche, Renault and etc.

ITEM NO.	DRIVE	SIZE	Teeth	● (mm)	L(mm)	🔧	📦
JDCD3310	1/2"	M10	33	17	110	10	80

**Star Alternator Combination Bit Socket (T50)**

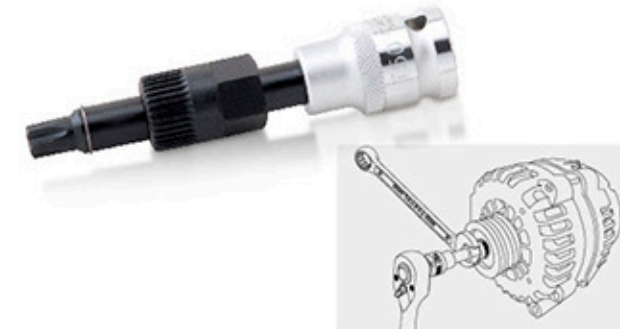

- The two-part alternator socket allows easy removal and replacement of the free-wheel drive pulley at the alternator
- This tool allows the alternator to be locked by the T50 star bit socket insert and enables the central locking bolt of the pulley to be loosened or tightened by the serrated reaction nut
- Use with 17mm wrench
- 33 teeth hexagonal reaction nut, O.D. 19.5mm
- Applications: Mercedes, Renault and etc.

ITEM NO.	DRIVE	SIZE	Teeth	● (mm)	L(mm)	🔧	📦
JDCD3350	1/2"	T50	33	17	110	10	80

**V-Belt Pulley Remover**



- Made of Chrome Vanadium Alloy Steel
- Special design to stop the pulley and remove the centre bolts for removing and installing the V-belt pulley at the generator
- Use with 17mm wrench and spline bit socket (M10) to remove and install the socket
- Applicable: VW Golf 3, Vento, Passat, AUDI A3, VOLVO and etc.

ITEM NO.	Teeth	● (mm)	O.D. Ø (mm)	I.D. Ø (mm)	L (mm)	🔧	📦
JDBD3317	33	17	19.5	11.8	30	10	180

**13PCS**

**Alternator Pulley Remover Kit**

- Designed for the easy removal of alternator free-wheel drive pulleys either on or off the vehicle
- Locks the alternator, allowing the central locking bolt of the pulley to be released
- Applications: BMW, VW, Audi, Mercedes, Renault, Ford, Porsche, Fiat and etc.



ITEM NO.	CONTENTS	📦 12 (SET)
JGA11301	<ul style="list-style-type: none"> <li>1 Spline Alternator Combination Bit Socket (W/33 Teeth Hex Reaction Nut) 1/2" Dr. x M10, L=110mm, Hex: 17mm</li> <li>1 Star Alternator Combination Bit Socket (W/33 Teeth Hex Reaction Nut) 1/2" Dr. x T50, L=110mm, Hex: 17mm</li> <li>2 10mm Hex Shank Hexagon Bits 8mm &amp; 10mm (L=75mm)</li> <li>2 10mm Hex Shank Star Bits T40 &amp; T50 (L=75mm)</li> <li>2 10mm Hex Shank Spline Bits M8 &amp; M10 (L=75mm)</li> <li>1 Quick Change Bit Holder 1/2" Dr. x 10mm (Hex)</li> <li>1 33 Teeth Hex Reaction Nut Hex: 17mm, O.D. 19.5mm, I.D. 11.8mm L=30mm</li> <li>1 33 Teeth Hex Reaction Nut Hex: 22mm, O.D. 19.5mm, I.D. 11.8mm L=30mm</li> <li>1 Hexagon Reaction Nut Hex: 22mm, I.D. 11.8mm L=32mm</li> <li>1 4 Pin Round Reaction Nut with Hex Tip Hex: 17mm, O.D. 35mm, I.D. 11.8mm L=37mm</li> </ul>	

BLOW CASE: W245 x D145 x H45 (mm)

TOPTUL Alternator Pulley Remover Kit allows the alternator to be locked by the Spline (M8, M10), Star (T40, T50) or Hex (8, 10mm) bits insert and enables the central locking bolt of the pulley to be loosened or tightened by the reaction nut

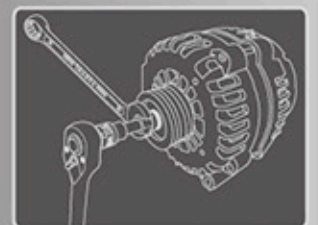

**13PCS ALTERNATOR PULLEY REMOVER KIT**

## Mechanic's Stethoscope

A mechanic's stethoscope is a sensitive instrument. It can be fitted with a variety of ends, including needle probes and rubber trumpets, specially designed for automotive use. This specially designed tool provides an effective and precise way to locate unusual noises in engines, bearings or other moving parts and to track down leaks or suspicious vibrations in valves, gaskets, piston rings and etc. Incorporate with rubber trumpets, it is also a handy tool for checking vacuum and pressure flow or for synchronizing multi carburetors.

▣ **Mechanic's Stethoscope**

**ITEM NO.** JDAX0102  12

- Effectively locating trouble spots within the engine block
- Listen for trouble by tracing sound of flowing water, oil, gas or steam
- Use to quickly identify piston slap, worn gears, faulty valves, water pump failure, damaged gaskets and defective bearings
- Ideal for pinpointing the source of noises in engines, transmissions, differentials and bearings as well as the unusual vibrations or suspected leaks
- Aluminum alloy probe extends to 275mm (10-13/16") allows safe access to hard to reach spots
- Supplied with Rubber trumpet for user quick checking vacuum and pressure flow
- Flexible tubing and shockproof PP material plastic sound conduction

▣ **Mechanic's Stethoscope**



**ITEM NO.** JDAX0101  20

- Effectively locating trouble spots within the engine block
- Listen for trouble by tracing sound of flowing water, oil, gas or steam
- Use to quickly identify piston slap, worn gears, faulty valves, water pump failure, damaged gaskets and defective bearings
- Ideal for pinpointing the source of noises in engines, transmissions, differentials and bearings as well as the unusual vibrations or suspected leaks
- 2 pieces metal probe extends to 300mm (11-3/4") allows safe access to hard to reach spots
- Flexible tubing and shockproof PS material plastic handle

▣ **Piston Ring Pliers**

- Made of high grade special tool steel
- For installing and removing piston rings
- Bright nickel-plated





ITEM NO.	CAPACITY Ø (mm)	L(mm)		
JABA0510	50 - 100	215	12	48
JABA0812	80 - 120	225	12	48
JABA1116	110 - 160	255	12	48

▣ **Piston Ring Compressor**

SUS



ITEM NO.	HEIGHT (inch)	CAPACITY (mm)		
JAAA1303	3	53 - 125	30	60
JAAA1804	4	90 - 175	30	60
JAAA1806	6	90 - 175	20	40



**56PCS**

**Professional Threaded Coil-Insert Repair Kit (For Spark Plug Thread)**

- Ideal for repairing and restoring damaged spark plug thread
- Completed set for easy and quick repairs of spark plug, thread insert size - M10, M12, M14
- Each size includes stainless steel screw coils, thread tap & Coil Shielding Collar, Coil Installation Shank and Hex Key Wrench

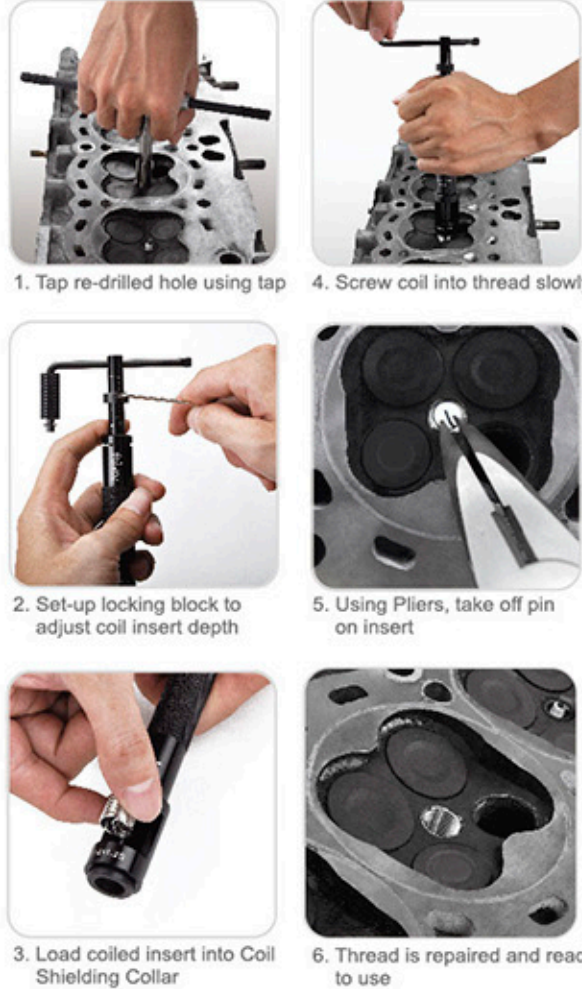

1. Tap re-drilled hole using tap  
2. Set-up locking block to adjust coil insert depth  
3. Load coiled insert into Coil Shielding Collar  
4. Screw coil into thread slowly  
5. Using Pliers, take off pin on insert  
6. Thread is repaired and ready to use

ITEM NO.	CONTENTS	10 (SET)
JGAI5601	<ul style="list-style-type: none"> <li>44 Stainless Steel Screw Coil Inserts</li> <li>15PCS - M10 x 1.0mm x 3/8" (L=9.5mm)</li> <li>15PCS - M12 x 1.25mm x 3/4" (L=19mm)</li> <li>15PCS - M14 x 1.25mm x 7/16" (L=11mm)</li> <li>1 Install Main Tool (P-type)</li> <li>3 Thread Taps</li> <li>M10 x 1.0mm, M12 x 1.25mm, M14 x 1.25mm</li> <li>3 Coil Shielding Collar</li> <li>M10, M12, M14</li> <li>3 Coil Installation Shank</li> <li>M10, M12, M14</li> <li>1 Hex Key Wrench</li> </ul>	
BLOW CASE: W298x D298 x H62 (mm)		

**3/8" DR. Deep Spark Plug Socket**

- Professional quality, 12-point deep sockets manufactured from hardened and tempered Chrome Vanadium Steel
- Designed for easy installation or removal of the deep-seated (deeply recessed) spark plugs
- Fitted with a rubber insert for plug protection and retention
- Knurled finger grips for hand starting
- Polished chrome plated



• Rubber insert for positive plug protection and retention

DRIVE	ITEM NO.	SIZE(mm)	L(mm)	D(mm)	Mirror Finished	24	288
3/8"	BSBA1214S	14	90	20	10	160	
	BSBA1214L	14	250	19	5	40	

**10PCS**

**Professional Threaded Coil-Insert Repair Kit (For Spark Plug Thread)**

- Ideal for repairing and restoring damaged spark plug thread
- For most commonly used metric bolt size M14, suitable for machine construction, engine repair and other automotive applications

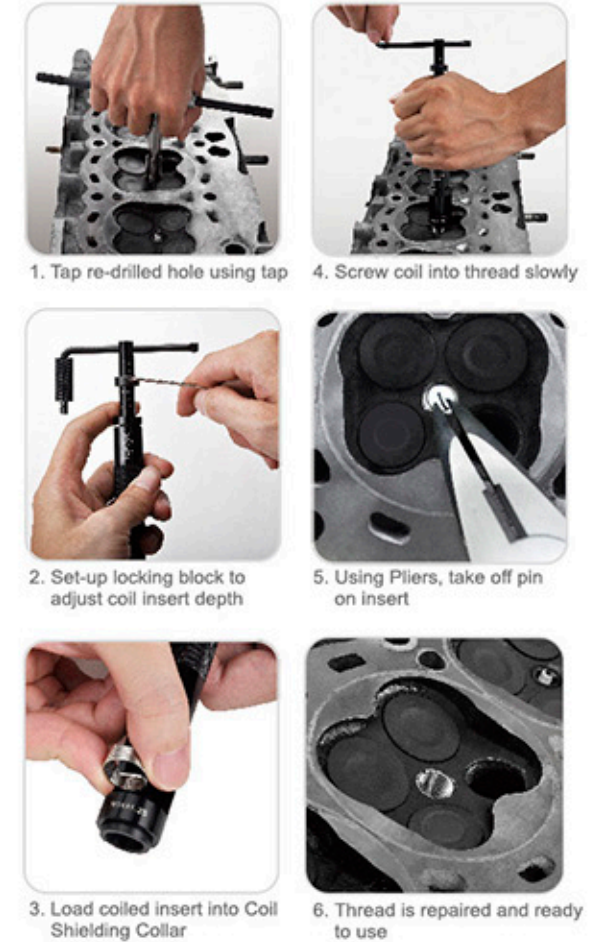

1. Tap re-drilled hole using tap  
2. Set-up locking block to adjust coil insert depth  
3. Load coiled insert into Coil Shielding Collar  
4. Screw coil into thread slowly  
5. Using Pliers, take off pin on insert  
6. Thread is repaired and ready to use

ITEM NO.	CONTENTS	30 (SET)
JGAI1003	<ul style="list-style-type: none"> <li>1 Install Main Tool (P-type)</li> <li>2 mm Hex Key Wrench</li> <li>1 HSS Thread Tap</li> <li>M14 x 1.25mm</li> <li>1 Coil Shielding Collar</li> <li>M14</li> <li>1 Coil Installation Shank</li> <li>M14</li> <li>1 Stainless Steel Screw Coil Inserts</li> <li>M14 x 1.25mm x 7/16" (L=11mm)</li> </ul>	
BLOW CASE: W250 x D128 x H41 (mm)		

**Spark Plug Gap Gauge (Coin Type)**

- Coin-type ramp gauge design to measure all type spark plug gaps easily
- Flanged hole design to adjust side wire without damaging center electrode
- Dual marked for both Imperial and Metric



ITEM NO.	Measuring range	24	288
JDBU0210	0.020" - 0.100" (0.6 - 2.4mm)		

**Battery Pole and Terminal Cleaner**

- Wire brushes remove corrosion build-up on battery pole and terminals for improved electrical contact
- The external brush cleans cable clamps, and the internal brush battery poles
- Metal case battery brush

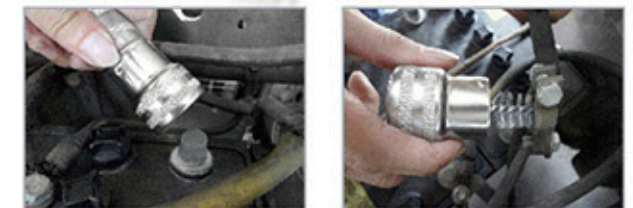

ITEM NO.	LENGTH(mm)	12	72
JDBV3984	84		



3/8" DR. Oxygen Sensor Socket (Low Profile Offset)

CR-MO



- Made of Chrome Molybdenum Steel, Heat Treated, Black Oxide Finish
- Remove & install sensors on computerized engine control vehicles
- 3/8" Dr. 7/8" (22mm) 6PT socket with cutaway length 30mm Portion for wire clearance
- Offset design for confined areas

ITEM NO.	SIZE(mm)	L(mm)	W	H
JDAR1222	22	30	25	100

1/2" DR. Oxygen Sensor Socket

CR-V



- Made of Chrome Vanadium Steel, Heat Treated, Black Oxide Finish
- Remove & install sensors on computerized engine control vehicles
- 1/2" Dr. 1-1/16" (27mm) 12PT socket with cutaway portion for wire clearance

ITEM NO.	SIZE (mm)	L (mm)	W	H
JDAQ1627	27	78	10	100

1/2" DR. Heated Oxygen Sensor Socket

CR-MO



- Made of heat treated, durable Chrome Molybdenum Alloy Steel
- Remove & install sensors on computerized engine control vehicles
- 7/8" (22mm) Hex, 1/2" Square Drive (double square for easy access)
- Socket with cutaway portion for wire clearance
- Offset design for confined areas
- Material: CR-MO
- Finish: Black Oxide

ITEM NO.	SIZE(inch)	L (mm)	W	H
JDAR0122	7/8	50	10	100

3/8" DR. Oxygen Sensor Vacuum Switch Socket

CR-V



- Made of heat treated Chrome Vanadium Steel
- Install and removes oxygen sensors and vacuum switches on computerized engine control vehicles
- 22mm (7/8") 6-point socket with cutaway slot provides extra clearance for sensor wires
- Use with 3/8" square drive tools or 1" end wrench on the external hex
- Black phosphate finish for added corrosion resistance

ITEM NO.	SIZE (mm)	L (mm)	W	H
JDAQ0122	22	90	12	72

1/2" DR. Oxygen Sensor Socket

CR-MO



ITEM NO.	SIZE(mm)	L(mm)	W	H
JDAQ1622	22	85	20	80



**AUTO TOOLS**  
Engine Series

7PCS Sensor & Sending Unit Socket Set

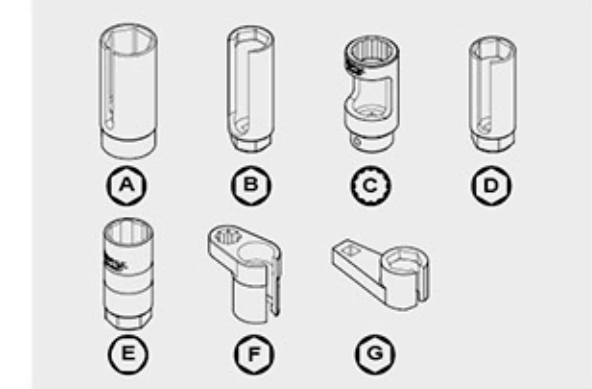

- Set contains 7 assorted sockets for removal and installation of Oxygen Sensor, Oil Pressure Sending Units and Vacuum Switches
- Specially designed tools to use and work on a variety of vehicles
- Sockets are made of heat treated, durable chrome vanadium alloy steel (A-E) and chrome molybdenum alloy steel (F&G)

ITEM NO.	CONTENTS	DRIVE	SIZE (inch)	L (mm)	W (mm)	H (mm)
JGAI0701	1 JDAS0129 Oil Pressure Sending Unit Socket	1/2"	1-3/16 (29mm)	90		
	1 JDAQ0122 Universal Vacuum PVS, TVS Valve and Oxygen Sensor Socket	3/8"	7/8	90		
	1 JDAQ1627 GM Thermal Sensor Switch Socket	1/2"	1-1/16 (27mm)	78		
	1 JDAQ0222 Oxygen Sensor Socket	3/8"	7/8	80		
	1 JDAS0227 Oil Pressure Sending Unit Socket	3/8"	1 & 1-1/16	74		
	1 JDAR0122 Heated Oxygen Sensor Socket	1/2"	7/8	50		
	1 JDAR0222 Low Profile Offset Oxygen Sensor Socket	3/8"	7/8	30		

BLOW CASE: W232 x D203 x H54 (mm)

3PCS 3/8" DR. Glow Plug Socket Set

- 6-point socket made of hardened and tempered chrome vanadium steel
- Internal rubber retaining ring for positive retention of plug in socket
- 180° universal joint design allows easy access in confined engine bays
- Suitable for the removal and replacement of glow plugs in most popular diesel engines
- Matt chrome plated finish
- Application: Mercedes, Audi, VW, Opel, Fiat and etc.



8 / 10 / 12MM



ITEM NO.	CONTENTS	W	H
JGAI0301	3 JDBM1208-JDBM1212 3/8" Dr. Glow Plug Sockets (75mmL) 8, 10, 12 mm	150	150

BLOW CASE: W120 x D81 x H36 (mm)

**Cotter Pin Puller**

CR-V

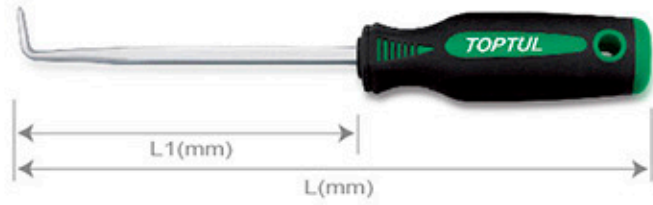

ITEM NO.	L1(mm)	L(mm)	Weight (g)	Volume (cm³)
JJAK0101	125	235	5	40

**Door Upholstery Remover**

CR-V

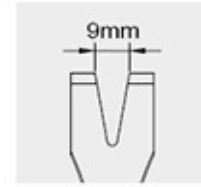

ITEM NO.	L1(mm)	L(mm)	Weight (g)	Volume (cm³)
JJAE1011	110	230	5	40

**Radiator Hose Remover**

CR-V



ITEM NO.	L1(mm)	L(mm)	Weight (g)	Volume (cm³)
JJAK0201	80	190	5	40

**Door Upholstery Remover**

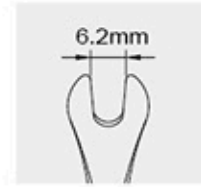

- Blade made from special high quality SVCM tool steel
- Rugged tool with a large comfortable bi-component PP+TPR plastic handle
- Removes plastic door panel fasteners without breakage

ITEM NO.	L1(mm)	L(mm)	Weight (g)	Volume (cm³)
JJAE0612	115	225	5	40

**Scraper**

CR-V



ITEM NO.	L1(mm)	L(mm)	Weight (g)	Volume (cm³)
JJAJ0813	125	245	5	40

**4PCS**

SUS

**Miniature Hook & Picks Set**



ITEM NO.	CONTENTS	Weight (g)	Volume (cm³)
GAAR0401	JJAK0301 Mini - Awl JJAK0303 Mini - Hook JJAK0304 Mini - Bent Tip 45° JJAK0302 Mini - Bent Tip 90°	10 (SET)	

**Door Upholstery Remover**

CR-V

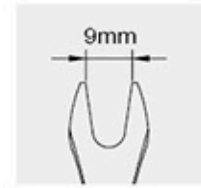

- For plastic upholstery fasteners
- Place tool under edge of door panel and insert into fastener as then simply pry up

ITEM NO.	L1(mm)	L(mm)	Weight (g)	Volume (cm³)
JJAE0812	120	245	10	40

**Stainless Steel Putty Knife (Flexible Scraper)**

SUS

**3PCS**

**Stainless Steel Putty Knife Set**



ITEM NO.	BLADE SIZE (W x L) (mm)	BLADE THICKNESS (mm)	Weight (g)	Volume (cm³)
JDAB3205	32 x 100	0.5	10	180
JDAB5005	50 x 100	0.5	10	180
JDAB7605	76 x 100	0.5	8	144

ITEM NO.	CONTENTS	Weight (g)	Volume (cm³)
JGAT0301	1 76 x 100 x 0.5 mm 1 50 x 100 x 0.5 mm 1 32 x 100 x 0.5 mm	20 (SET)	



**Stainless Steel Bolstered Scraper**

SUS

**3PCS**

**Stainless Steel Bolstered Scraper Set**



ITEM NO.	BLADE SIZE (W x L) (mm)	BLADE THICKNESS (mm)	Weight (g)	Volume (cm³)
JDAD3218	32 x 100	1.8	10	180
JDAE3218	32 x 100	1.8	10	180
JDAD5018	50 x 100	1.8	10	180

ITEM NO.	CONTENTS	Weight (g)	Volume (cm³)
JGAT0302	1 50 x 100 x 1.8 mm Straight Blade 1 32 x 100 x 1.8 mm Bent Blade 1 32 x 100 x 1.8 mm Straight Blade	20 (SET)	



**Stainless Steel Pinchweld Scraper**

SUS

**4PCS**

**Stainless Steel Pinchweld Scraper Set**



ITEM NO.	BLADE SIZE (W x L) (mm)	BLADE THICKNESS (mm)	Weight (g)	Volume (cm³)
JDAD3225	32 x 100	2.5	10	180
JDAC2012	20 x 50	1.2	10	180
JDAC2025	20 x 50	2.5	10	180
JDAD3212	32 x 100	1.2	10	180

ITEM NO.	CONTENTS	Weight (g)	Volume (cm³)
JGAT0401	1 32 x 100 x 2.5 mm 1 20 x 50 x 1.2 mm 1 20 x 50 x 2.5 mm 1 32 x 100 x 1.2 mm	20 (SET)	



Curved Dolly



ITEM NO.	W(mm)	H(mm)	L(mm)		
JFBA0108	58	70	80	4	12

Double End Round Dolly



ITEM NO.	W(mm)	L(mm)		
JFBD0106	Ø56	58	6	12

Heel Dolly



ITEM NO.	W(mm)	H(mm)	L(mm)		
JFBJ0108	61	30	79	6	24

Curved Dolly



ITEM NO.	W(mm)	H(mm)	L(mm)		
JFBI0113	58	45	133	6	12

Utility Dolly



ITEM NO.	W(mm)	H(mm)	L(mm)		
JFBH0107	70	64	70	6	12

Angle Dolly



ITEM NO.	W(mm)	H(mm)	L(mm)		
JFBF0111	59	16	108	6	24

Double End Hand Dolly



ITEM NO.	W(mm)	H(mm)	L(mm)		
JFBD0208	62	75	66	6	12

Toe Dolly



ITEM NO.	W(mm)	H(mm)	L(mm)		
JFBG0112	58	29	121	6	12

Anvil Dolly



ITEM NO.	W(mm)	H(mm)	L(mm)		
JFBB0110	72	62	102	4	16

Thin Toe Dolly



ITEM NO.	W(mm)	H(mm)	L(mm)		
JFBG0212	55	24	118	6	24

Shrinking Dolly



ITEM NO.	W(mm)	H(mm)	L(mm)		
JFBG0412	58	29	120	6	12

Grid Dolly



ITEM NO.	W(mm)	H(mm)	L(mm)		
JFBG0312	58	30	120	6	12

Large End Dolly



ITEM NO.	W(mm)	H(mm)	L(mm)		
JFBE0113	70	125	90	4	16

Round Peen End Dolly



ITEM NO.	W(mm)	H(mm)	L(mm)		
JFBC0113	44	Ø54	125	6	24

Double Blade Spoon



ITEM NO.	W(mm)	H(mm)	L(mm)		
JFCC0140	58	172	401	4	8
JFCC0251	59	179	510	2	8

Anvil Dolly



ITEM NO.	W(mm)	H(mm)	L(mm)		
JFBE0215	67	146	139	2	12

Dome Dolly



ITEM NO.	W(mm)	H(mm)	L(mm)		
JFBE0315	61	30	155	2	16

Light Dinging Spoon



ITEM NO.	W(mm)	H(mm)	L(mm)		
JFCA0127	48	58	250	12	72

Drip Moulding Spoon



ITEM NO.	W(mm)	H(mm)	L(mm)		
JFCD0124	49	70	235	6	12

Flat Spoon

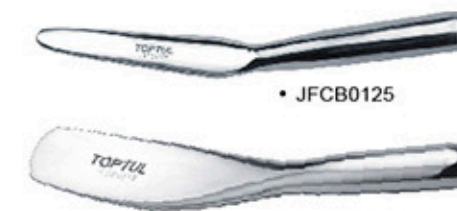

ITEM NO.	W(mm)	H(mm)	L(mm)		
JFCB0125	30	99	250	12	48
JFCB0229	51	68	286	6	24

# HAMMER

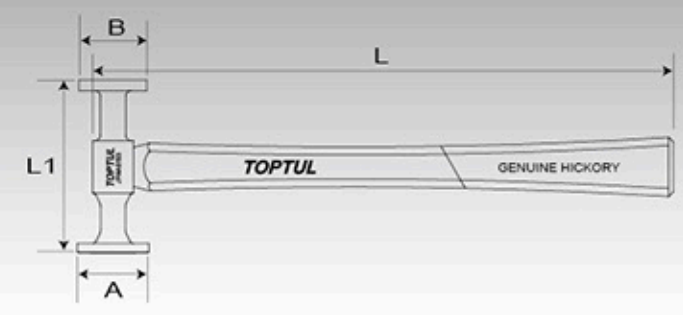

**Heavy Shrinking Hammer**  
- Flat Face + Shril Milled Square Face

**Standard Bumping Hammer**  
- Crowned Face

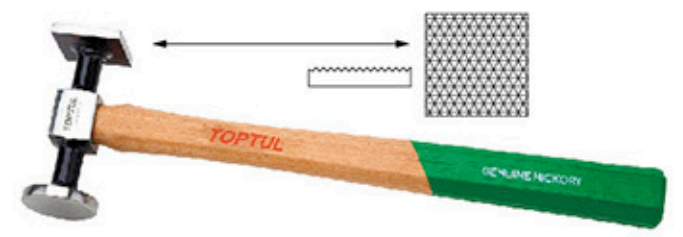

ITEM NO.	A(mm)	B(mm)	L1(mm)	L(mm)	Weight	Length
JFAB0133	Ø40	38 x 38	100	325	6	36

ITEM NO.	A(mm)	B(mm)	L1(mm)	L(mm)	Weight	Length
JFAA0233	Ø40	38 x 38	98.5	325	6	36

**Light Shrinking Hammer**  
- Flat Face + Milled Square Face

**Light Bumping Hammer**  
- Flat Face

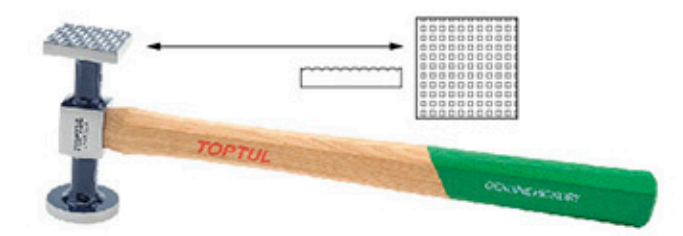

ITEM NO.	A(mm)	B(mm)	L1(mm)	L(mm)	Weight	Length
JFAB0233	Ø40	38 x 38	100	325	6	36

ITEM NO.	A(mm)	B(mm)	L1(mm)	L(mm)	Weight	Length
JFAA0333	Ø32	25 x 25	91	325	6	36

**Standard Bumping Hammer**  
- Flat Face

**Light Bumping Hammer**  
- Crowned Face



ITEM NO.	A(mm)	B(mm)	L1(mm)	L(mm)	Weight	Length
JFAA0133	Ø40	38 x 38	100	325	6	36

ITEM NO.	A(mm)	B(mm)	L1(mm)	L(mm)	Weight	Length
JFAA0433	Ø32	25 x 25	91	325	6	36

**Reverse Curve Hammer**  
- Crowned Face

**Curved Pein & Finishing Hammer**  
- Crowned Face



ITEM NO.	A(mm)	B(mm)	L1(mm)	L(mm)	Weight	Length
JFAA0533	Ø29.5	25.5 x 25.5	104	325	6	36

ITEM NO.	A(mm)	L1(mm)	L(mm)	Weight	Length
JFAC0233	Ø40	140	325	6	36

**Pick & Finishing Hammer**  
- Crowned Face

**Straight Pein & Finishing Hammer**  
- Crowned Face



ITEM NO.	A(mm)	L1(mm)	L(mm)	Weight	Length
JFAC0333	Ø40	138	325	6	36

ITEM NO.	A(mm)	L1(mm)	L(mm)	Weight	Length
JFAC0133	Ø40	141	325	6	36

**7PCS Professional Grade Auto Body Repair Tool Set**



- Professional quality meets industrial standards
- Drop forged tool steel dollies, heat treated, includes Utility Dolly, Curved Dolly, Heel Dolly and Toe Dolly
- Drop forged tool steel hammers, selected hickory, includes Pick & Finishing Hammer, Shrinking Hammer and Standard Bumping Hammer
- Easy latch case holds all tools securely in place and provides excellent tool protection

ITEM NO.	CONTENTS	Weight
GAAI0702	1 JFAB0233 - Light Shrinking Hammer (Flat Face + Milled Square Face) 1 JFAA0133 - Standard Bumping Hammer 1 JFAC0333 - Pick & Finishing Hammer (Crowned Face) 1 JFBI0113 - Curved Dolly 1 JFBG0112 - Toe Dolly 1 JFBJ0108 - Heel Dolly 1 JFBH0107 - Utility Dolly	3 (SET)

BLOW CASE: W478 x D234 x H100 (mm)

**Heavy Duty Clamp**

- Single-way pull operation
- Bolt Size: Ø19 mm x 140 mm (L)
- Gripping Surface: 46mm (wide) / 21mm (deep)
- Material: Drop Forged Chrome Molybdenum Alloy Steel

CR-MO

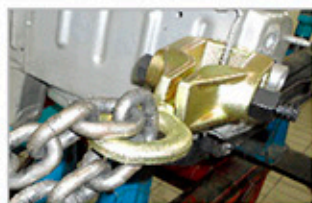

<b>ITEM NO.</b>	Pulling Capacity (tons)		
JFDA0105	5	1	6

**Box Clamp**

- Single-way pull operation
- Two sides of the jaws are different in order to fit the confined space
- Bolt Size: Ø14 mm x 120 mm (L)
- Gripping Surface: 37mm (wide) / 15mm (deep)
- Material: Drop Forged Chrome Molybdenum Alloy Steel

CR-MO



<b>ITEM NO.</b>	Pulling Capacity (tons)		
JFDB0303	3	1	6

**Big Mouth Clamp**

- Single-way pull operation
- Bolt Size: Ø14 mm x 120 mm (L)
- Gripping Surface: 37mm (wide) / 15mm (deep)
- Material: Drop Forged Chrome Molybdenum Alloy Steel

CR-MO



<b>ITEM NO.</b>	Pulling Capacity (tons)		
JFDB0103	3	1	6

**Small Mouth Pull Clamp**

- Single-way pull operation
- Perfect to use in the confined space
- Bolt Size: Ø17 mm x 80 mm (L)
- Gripping Surface: 44mm (wide) / 24mm (deep)
- Material: Drop Forged Chrome Molybdenum Alloy Steel

CR-MO



<b>ITEM NO.</b>	Pulling Capacity (tons)		
JFDC0105	5	1	6

**Box Clamp (Two-Way)**

- Two-way pull operation
- Bolt Size: Ø14 mm x 120 mm (L)
- Gripping Surface: 37mm (wide) / 15mm (deep)
- Material: Drop Forged Chrome Molybdenum Alloy Steel

CR-MO



<b>ITEM NO.</b>	Pulling Capacity straight way (tons)	Pulling Capacity cross way (tons)		
JFDB0203	3	2	1	6

**Small Mouth Pull Clamp (Two-Way)**

- Two-way pull operation
- Perfect to use in the confined space
- Bolt Size: Ø17 mm x 80 mm (L)
- Gripping Surface: 44mm (wide) / 24mm (deep)
- Material: Drop Forged Chrome Molybdenum Alloy Steel

CR-MO



<b>ITEM NO.</b>	Pulling Capacity straight way (tons)	Pulling Capacity cross way (tons)		
JFDC0205	5	2	1	6

**Thin Edge Mouth Clamp**

- Single-way pull operation
- Perfect to use in hard to reach places
- Spring-loaded for easy opening
- Bolt Size: Ø12 mm x 65 mm (L)
- Gripping Surface: 33mm (wide) / 27mm (deep)
- Material: Drop Forged Chrome Molybdenum Alloy Steel

CR-MO



<b>ITEM NO.</b>	Pulling Capacity (tons)		
JFDD0105	5	1	12

**Frame Rack Clamp (Two-Way)**

- Two-way pull operation
- The special puller design used with plate increases tool durability
- Bolt Size: Ø17 mm x 72 mm (L)
- Gripping Surface: 118mm (wide) / 18mm (deep)
- Material: Drop Forged Chrome Molybdenum Alloy Steel

CR-MO



<b>ITEM NO.</b>	Pulling Capacity straight way (tons)	Pulling Capacity cross way (tons)		
JFDE0205	5	3	1	6

**Mini Clamp (Two-Way)**

- Two-way pull operation
- Bolt Size: Ø12 mm x 44 mm (L)
- Gripping Surface: 37mm (wide) / 12mm (deep)
- Material: Drop Forged Chrome Molybdenum Alloy Steel

CR-MO



<b>ITEM NO.</b>	Pulling Capacity straight way (tons)	Pulling Capacity cross way (tons)		
JJDF0203	3	2	1	10

**Frame Rack Clamp**

- Single-way pull operation
- The special puller design used with plate increases tool durability
- Bolt Size: Ø17 mm x 72 mm (L)
- Gripping Surface: 118mm (wide) / 18mm (deep)
- Material: Drop Forged Chrome Molybdenum Alloy Steel

CR-MO



<b>ITEM NO.</b>	Pulling Capacity (tons)		
JFDE0105	5	1	6

**Double Hook Clamp (Double Claw Hook)**

- Body repair chain joint with double claw hooks
- For use as a chain shortener or chain connector
- Use with 5/16", 3/8" chains
- Material: Drop Forged Chrome Molybdenum Alloy Steel

CR-MO



<b>ITEM NO.</b>	Pulling Capacity (tons)		
JFEA0106	6	1	10



**TOPTUL**  
Auto Body Collision Repair Clamps

# Auto Tools - Body Series

- NEW

## Slide Hammer Dent Puller Set



ITEM NO. JGAI1202 2 (SET)

**Features:** Commonly used tool set to use on body panel and vehicle chassis. Designed to work on body repair, chassis, bumper ends, fender edge, door, door edge...etc or other unique pulling applications. Heavy duty slide hammer action with 10 lbs hammer and various attachments; Slide Shaft, Slide Hammer, Washer, Slide Shaft Handle, Flat Pipe, Large Hook Type Plate, Small Hook Type Plate, 90 Angle Thick Hook Plate, 90 Angle Thin Hook Plate, Two Hole Pipe, Flat Plate, Chain & Hook, Screw Puller to suit different pulling jobs.

BLOW CASE: W600 x D210 x H100 (mm)

### KIT CONTENT



NO.	Description	Q'ty
1	Slide Shaft	1
2	Slide Hammer	1
3	Flat Pipe	1
4	Large Hook Type Plate	1
5	Small Hook Type Plate	1
6	90 Angle Thick Hook Plate	1
7	90 Angle Thin Hook Plate	1
8	Two Hole Pipe	1
9	Flat Plate	1
10	Chain & Hook	1
11	Screw Puller	1
12	Washer	1
13	Slide Shaft Handle	1

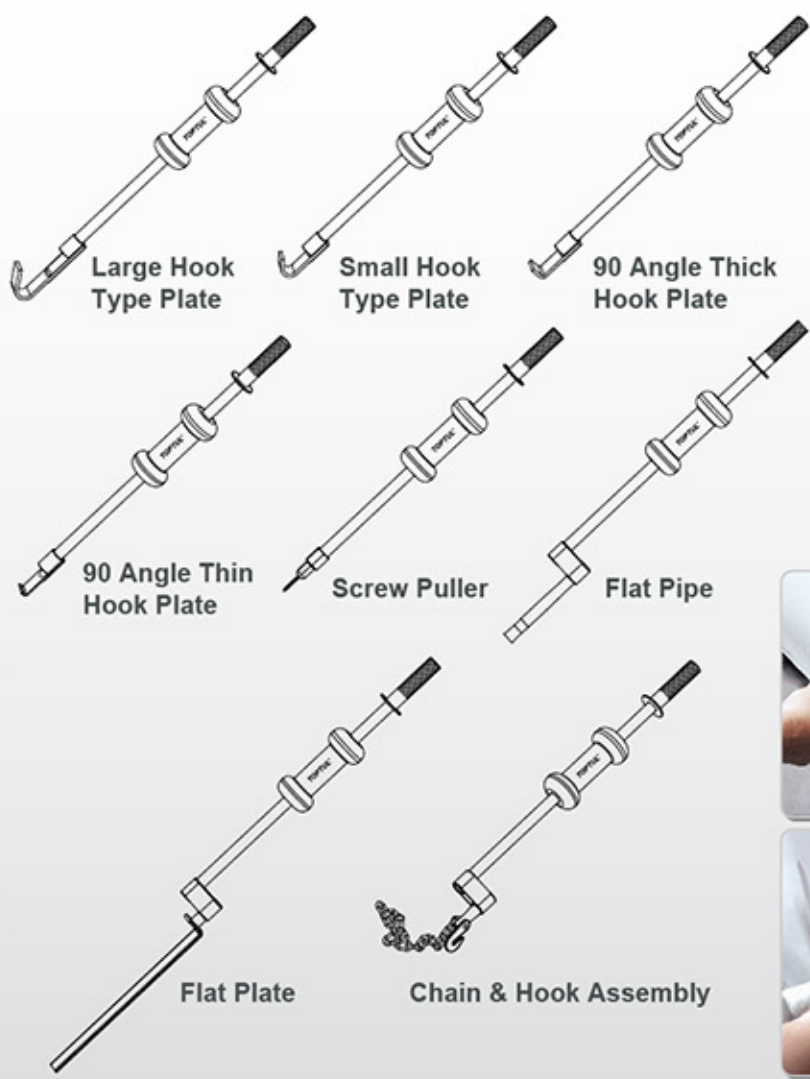

### Self-Locking Multi-Grip Pliers with Wide Flat Jaws

- Chrome Molybdenum Alloy Steel Jaw
- Clamps lap joints allowing four consecutive spot welds without tool removal
- Suitable for spot welding and auto-body repair works
- Easy one-handed push button release



ITEM NO.	JAW ADJUSTMENT(mm)	L(mm)	W	H
DMAI1A08	0 - 12	200	12	24

### Self-Locking Multi-Grip Pliers with Double Curved Jaws

- Chrome Molybdenum Alloy Steel Jaw
- Clamps two flanged lapped or adjacent joints
- Suitable for auto-body repair works
- Easy one-handed push button release



ITEM NO.	JAW ADJUSTMENT(mm)	L(mm)	W	H
DMAJ1A09	0 - 10	230	12	24

### Self-Locking Multi-Grip Pliers with Wide Curved Jaws

- Chrome Molybdenum Alloy Steel Jaw
- Clamps two butt or adjacent joints
- Enables to work in tight spots
- Easy one-handed push button release



ITEM NO.	JAW ADJUSTMENT(mm)	L(mm)	W	H
DMAK1A09	0 - 10	215	12	36

### Self-Locking Multi-Grip Pliers with Angled Jaws

- Chrome Molybdenum Alloy Steel Jaw
- Clamps two flanged lap joints
- Enables to work in tight spots
- Easy one-handed push button release



ITEM NO.	JAW ADJUSTMENT(mm)	L(mm)	W	H
DMAL1A09	0 - 15	210	6	36

**Self-Locking Multi-Grip Pliers with Straight Jaws**

- Chrome Molybdenum Alloy Steel Jaw
- Allows to work in narrow areas
- Easy one-handed push button release



ITEM NO.	JAW ADJUSTMENT(mm)	L(mm)		
DMAM1A08	0 - 18	195	6	36

**Plugweld Locking Pliers**

- Solid copper pad on fixed jaw prevents burn-through when plug welding thin sheet-metal panels
- Weld does not stick to copper which also allows for quick cooling
- U-shape bottom jaw provides even pressure around welding spot
- Quick-release level easily unlocks the pliers

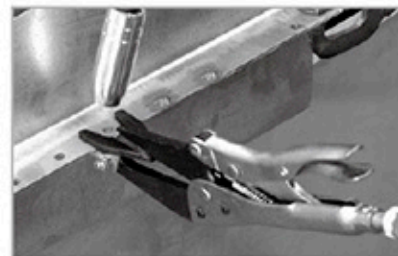

ITEM NO.	JAW ADJUSTMENT(mm)	L(mm)		
DMAH1A10	0 - 50	250	10	50

**Trim Clip Removal Pliers**

- For quick removing staples, clips, door panels, fascia and trim supports without damage
- Wide nose design to prevent breaking or tearing panels when undoing facings
- Designed for accessing difficult to reach places
- Made of Chrome Molybdenum Steel, Black pliers head, comfort grip handle
- Total length: 240mm (9-1/2")

CR-MO



ITEM NO.	LENGTH (mm)		
JJAN0109	240 (9-1/2")	12	36

**Trim Removal Wedge**

- Made from high impact resistant nylon material to minimize scratches
- Smooth tapered design simplifies insertion
- Hang-up design for convenient storage
- Place tool under edge of panel or trim to remove trims and internal fittings



ITEM NO.	SIZE(L) x (W) x (H)mm		
JJAP1219	190 x 30 x 23	8	128

**6PCS**

**Mini Handy Remover Set**

- Made from high impact resistant nylon material to minimize scratches
- Specific slim profile design and unique shape for easy removal
- Place tool under edge of panel or trim to remove trims and internal fittings

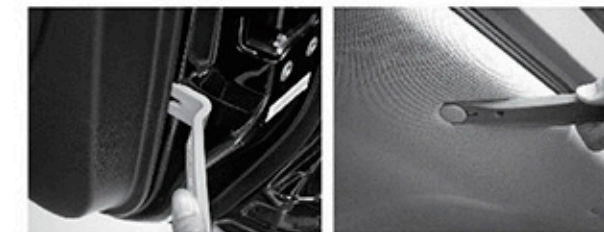

Angled Clip Panel Remover Flat Clip Panel Remover



Panel Remover Sharp Panel Remover

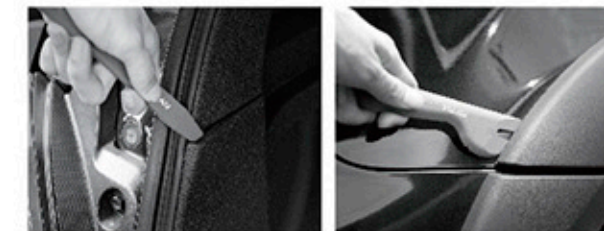

Straight Panel Remover Clip Panel Remover

ITEM NO.	CONTENTS		
JGAS0601	1 JJAP0620 Angled Clip Panel Remover - 30 x 200mm 1 JJAP0720 Flat Clip Panel Remover - 30 x 200mm 1 JJAP0820 Panel Remover - 24 x 200mm 1 JJAP0920 Sharp Panel Remover - 24 x 200mm 1 JJAP1020 Straight Panel Remover - 17 x 200mm 1 JJAP1120 Clip Panel Remover - 37 x 200mm	12 (SET)	

**5PCS**

**Handy Remover Set**

- For plastic upholstery fasteners
- Place tool under edge of door panel and insert into fastener as fast as possible, and then simply pry up
- Large support area to protect clips and pad



Remover Wide Type Remover Narrow Type



Handy Remover Upholstery Clip Remover

ITEM NO.	CONTENTS		
JGAS0501	1 JJAP0516 Remover Wide Type - 60 x 160mm 1 JJAP0421 Upholstery Clip Remover - 20 x 210mm 1 JJAP0318 Remover Narrow Type - 20 x 180mm 1 JJAP0220 Handy Remover - 30 x 200mm 1 JJAP0118 Remover Pull Type - 30 x 180mm	12 (SET)	

## Auto Tools - General Tools Series

### Tube Cutter, Flaring & Swaging Tool Set

- 45° Flares and swages soft steel tubing such as soft copper, aluminum and brass tubing
- Swages in close quarters where punch style cannot be used
- Flaring bar with size capacity: 1/8", 3/16", 1/4", 5/16", 3/8", 7/16", 1/2", 5/8", 3/4" O.D. tubing
- Tube cutter capacity: 1/8" to 1-1/8"
- Swage adapters: 3/16", 1/4", 5/16", 3/8", 1/2", 5/8", 3/4"



ITEM NO.	CONTENTS	10 (SET)
JGAI1001	1 Flaring Bar (Small Size) 1/8", 3/16", 1/4", 5/16", 3/8", 7/16" O.D. Tubing	
	1 Flaring Bar (Large Size) 1/2", 5/8", 3/4" O.D. Tubing	
	1 Tube Cutter W/Retractable Reamer Cutting capacity: 1/8" to 1-1/8"	
	1 Steel Yoke	
	5 Swaging Adapter 3 in 1(3/16", 1/4", 3/8"), 5/16", 1/2", 5/8", 3/4"	
1 45° Flaring Adapter		

BLOW CASE: W265 x D215 x H62 (mm)

### Tube Cutter & Double Flaring Tool Set

- Specially designed tool kit to double flare tubing for high pressure application in automotive, air conditioning and etc.
- Accurately single or double flares soft steel tubing such as cooper, aluminum and brass tubing for leak free connections
- Screw-type 45° flaring press
- Tube cutter capacity: 1/8" to 1-1/8"
- Flaring bar & adapter sizes: 3/16", 1/4", 5/16", 3/8", 7/16", 1/2", & 5/8"

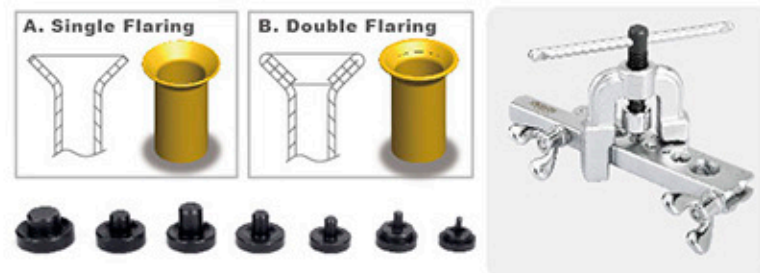

ITEM NO.	CONTENTS	12 (SET)
JGAI1002	1 Flaring Bar 3/16", 1/4", 5/16", 3/8", 7/16", 1/2", 5/8" O.D. Tubing	
	1 Tube Cutter W/Retractable Reamer Cutting capacity: 1/8" to 1-1/8"	
	1 Steel Yoke W/45° Flaring Cone	
	7 Flaring Adapter 3/16", 1/4", 5/16", 3/8", 7/16", 1/2", 5/8" O.D. Tubing	

BLOW CASE: W275 x D205 x H50 (mm)

### Automotive Circuit Tester

- Testing electrical circuits from 3 to 48 volts DC
- 2 LEDs indicate live circuit and positive (+) / negative (-) polarity
- Universal test instrument for motor vehicle electrics and electronics
- Supplied with 90 cm cable and insulated alligator clip
- CE certified



ITEM NO.	TEST VOLTAGE RANGE	L (mm)	10	100
JJDC0148	3 - 48V DC	135		

### Air Blow and Suction Gun



ITEM NO.	GDAE0701	20 (SET)
<ul style="list-style-type: none"> <li>• Air Inlet: 1/4" PT</li> <li>• Working Pressure: 90 PSI</li> <li>• Quick changes from vacuum to blower</li> <li>• Ideal cleaning accessory for garages and workshops</li> <li>• Content: Pistol grip designed aluminum gun, flexible plastic hose, dust collection bag, round nozzle, brush nozzle, flat nozzle and tiny nozzle</li> </ul>		

### Mechanic's Mat / Kneeling Pad

- Made of 3 layered padded construction EVA form soft material
- Dirt, water, liquid, oil, gasoline resistant mat
- Quick and easy to clean surface
- Universal use in workshops, service and breakdown service vehicles



• M485



• M960

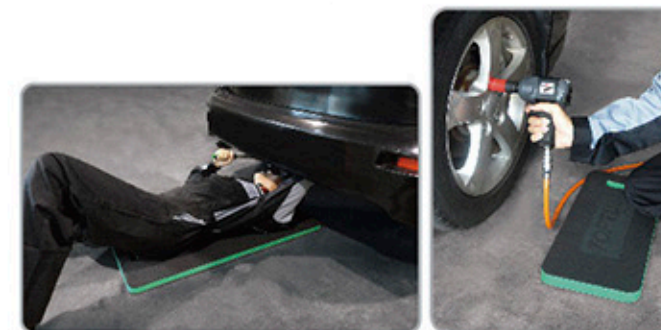

ITEM NO.	SIZE (L) x (W) x (H)mm	1	12
M485	485 x 225 x 30		
M960	960 x 380 x 30		

### 394PCS Rubber O-Ring Assortment Kit



- Universal O-Ring assortment, perfect for professional workshops and garages
- O-ring made of Nitrile Rubber (NBR 70) material
- Kit contains the most commonly used metric sizes o-rings for industrial and automotive applications
- 32 different sizes in metric measurements

ITEM NO.	CONTENTS	20 (SET)
JGEW394A	Metric O-Ring Sizes: (I.D.xThickness)	
	3 x 1 (36pcs), 4 x 1 (17pcs), 5 x 2 (9pcs), 6 x 2 (17pcs), 8 x 2 (17pcs), 10 x 2 (17pcs), 11 x 2 (17pcs), 12 x 2 (17pcs), 14 x 2 (17pcs), 17 x 2 (17pcs), 20 x 2 (17pcs), 10 x 3 (11pcs), 12 x 3 (11pcs), 16 x 3 (11pcs), 18 x 3 (11pcs), 22 x 3 (11pcs), 20 x 4 (9pcs), 22 x 4 (9pcs), 24 x 4 (9pcs), 25 x 4 (9pcs), 30 x 4 (9pcs), 34 x 4 (9pcs), 36 x 4 (9pcs), 40 x 4 (9pcs), 45 x 4 (9pcs), 47 x 4 (9pcs), 50 x 4 (9pcs), 16 x 5 (7pcs), 25 x 5 (14pcs), 30 x 5 (7pcs), 32 x 5 (7pcs), 35 x 5 (7pcs)	

PLASTIC BOX: W275 x D160 x H45 (mm)

### Magnetic Car Fender Cover W/Pockets



- Perfect for engine repair jobs to avoid paintwork damages
- 8 pieces high powered magnets for sure grip
- 4 tool holding pockets with a maximum loading weight up to 1.5kg

ITEM NO.	SIZE (W) x (L)mm	1	12
JJAQ1106	1070 x 600 (42" x 23-1/2")		





Other Tools Series

Essential

mechanical tools include pullers, crimping tools & bolt cutters.

388

www.toptul.com

OTHER TOOLS SERIES

387

Auto Tools - General Tools Series

20PCS

Radio Removal Tool Set



ITEM NO. JGAA2001 50 (SET)

- Expert quality, selection of keys for the removal and installation of car radios by garages, emergency services and specialist car audio installers
- Suitable for a wide range of applications including VW, BMW, Mercedes Benz, Audi, Opel, Porsche, Renault, Fiat, Peugeot, Ford, Skoda, Alpine, Grundig, Blaupunkt, Becker, Clarion, JVC, Pioneer & VDO

23PCS

Universal Terminal Release Tool Set



ITEM NO. JGAI2301 4 (SET)

- Special designed to release terminals from the plastic connectors without damaging to wires or terminal blocks
- Release terminals on most body wiring connectors
- Assortment of 23 parts for universal application in the auto wire terminal
- Application : BMW, Mercedes, Opel, VW, Audi, Porsche, Ford, Seat, Skoda, Jaguar, Citroen, Fiat, Saab, Mazda, Renault, Chrysler, Toyota, Honda, Mitsubishi and most vehicles

BLOW CASE: W435 x D250 x H75 (mm)

Spark Plug Terminal Pliers



- Specially designed tool to remove cable terminals from spark plugs quickly and safely
- Curved designed jaws grip the cable terminals tightly without damages
- Heavy-duty plastic coating for pliers' jaws and handles provides a shockproof sure grip

ITEM NO. JIAA0108 LENGTH (mm) 200 (8") 6 72

Plastic Creeper

- Rigid molded, one piece plastic construction
- Shaped arm areas for optimal movement freedom
- Padded head support
- Two built-in tool trays (right & left)
- Six 3" PU swivel caster wheels for easy maneuverability
- Practical hand carry handle
- Maximum load: 135 kg



ITEM NO. JCM-03 SIZE (L) x (W) x (H)mm 1020 x 480 x 115 1

Mechanic's Roller Seat

- Practical mechanic's roller work seat
- Durable powder coated steel frame
- Foam cushioned seat with wipe clean surface
- Seat cushion is removable and can be used as a great kneeling pad
- Bottom storage area provides easy and quick access to miscellaneous tools and parts
- Perfect height for wheel, brake or body works and all kind of low repair jobs
- 4 long-wearing 2" high impact poly swivel casters
- Maximum seat height: 305mm
- Seat area: 350 x 200 mm
- Maximum loading capacity up to 120 kg



ITEM NO. JCA-350A SIZE (L) x (W) x (H)mm 350 x 300 x 305 1

